

**Public Interest Energy Research (PIER) Program
White Paper**

**VULNERABILITY AND ADAPTATION
TO CLIMATE CHANGE IN
CALIFORNIA AGRICULTURE**

A White Paper from the California Energy Commission's California Climate Change Center

Prepared for: California Energy Commission

Prepared by: University of California, Davis

JULY 2012

CEC-500-2012-031

Louise Jackson
Van R. Haden
Stephen M. Wheeler
Allan D. Hollander
Josh Perlman
Toby O'Geen
Vishal K. Mehta
Victoria Clark
John Williams



University of California, Davis

DISCLAIMER

This paper was prepared as the result of work sponsored by the California Energy Commission. It does not necessarily represent the views of the Energy Commission, its employees or the State of California. The Energy Commission, the State of California, its employees, contractors and subcontractors make no warrant, express or implied, and assume no legal liability for the information in this paper; nor does any party represent that the uses of this information will not infringe upon privately owned rights. This paper has not been approved or disapproved by the California Energy Commission nor has the California Energy Commission passed upon the accuracy or adequacy of the information in this paper.

ACKNOWLEDGEMENTS

For the Yolo County case study, we greatly appreciate the involvement of our steering committee in many aspects of this project: John Young (Yolo County Agricultural Commissioner), Chuck Dudley (President of the Yolo County Farm Bureau), John Mott-Smith (Yolo County Climate Change Coordinator), Hasan Bolkan (Campbell Soup), and Tony Turkovich, and Jim and Deborah Durst (farmers in Yolo County). The University of California Cooperative Extension farm advisors of Yolo County provided much information and support (Gene Miyao, Rachel Long, and County Director, Kent Brittan). We would like to thank Tim O'Halloran, Max Stevenson, and the staff of the Yolo County Flood Control and Water Conservation District for their generous contributions of data, time, and insight. For the assessment of agricultural greenhouse gas emissions, we are grateful for discussions and information exchange with many farmers and organizations in Yolo County, especially the Yolo County Planning and Public Works Department, Ascent Environmental, and AECOM. Planning of the entire project benefitted from discussions with David Shebazian and the staff of the Sacramento Area Council of Governments (SACOG). For technical input on greenhouse gas inventory methods we wish to thank Webster Tasat and Shelby Livingston at the California Air Resources Board and Stephane de la Rue du Can at the Lawrence Berkeley National Laboratory. We would also like to thank Dr. Changsheng Li for DeNitrification-DeComposition model calibration and testing for California rice agroecosystems. Funding for the DeNitrification-DeComposition modeling of emissions from rice was provided by Conservation Innovation Grant program administered by the National Resource Conservation Service; Agreement Number NRCS 69-3A75-7-87. For the Long-range Energy Alternatives Planning (LEAP) study on on-farm renewable energy, we would like to thank the Lester Family for their involvement, discussion, and permission to peruse their records as a part of the LEAP study. We thank David Purkey and the Stockholm Environment Institute for a core grant that provided financial support for the energy modeling LEAP study and their water modeling expertise in the Yolo County Water Evaluation and Planning (WEAP) study. We are grateful to Fetzer/Bonterra Vineyards for their support and involvement in the assessment of carbon stocks across their ranches, and especially wish to thank Dr. Ann Thrupp of Fetzer Vineyards, and University of California Cooperative Extension farm advisor in Mendocino County, Glenn McGourty. We also would like to thank Jim Thorne and Jackie Bjorkman for providing access to their statewide UPlan model output. We also acknowledge Dan Cayan and Mary Tyree of the Scripps Institution of Oceanography for their provision of downscaled climate data.

PREFACE

The California Energy Commission's Public Interest Energy Research (PIER) Program supports public interest energy research and development that will help improve the quality of life in California by bringing environmentally safe, affordable, and reliable energy services and products to the marketplace.

The PIER Program conducts public interest research, development, and demonstration (RD&D) projects to benefit California. The PIER Program strives to conduct the most promising public interest energy research by partnering with RD&D entities, including individuals, businesses, utilities, and public or private research institutions.

PIER funding efforts are focused on the following RD&D program areas:

- Buildings End-Use Energy Efficiency
- Energy Innovations Small Grants
- Energy-Related Environmental Research
- Energy Systems Integration
- Environmentally Preferred Advanced Generation
- Industrial/Agricultural/Water End-Use Energy Efficiency
- Renewable Energy Technologies
- Transportation

In 2003, the California Energy Commission's PIER Program established the California Climate Change Center to document climate change research relevant to the states. This center is a virtual organization with core research activities at Scripps Institution of Oceanography and the University of California, Berkeley, complemented by efforts at other research institutions.

For more information on the PIER Program, please visit the Energy Commission's website <http://www.energy.ca.gov/research/index.html> or contact the Energy Commission at (916) 327-1551.

ABSTRACT

To build public support for adapting to and mitigating climate change, it will be necessary to develop greater awareness of a broad set of biophysical and socioeconomic factors that influence agricultural vulnerability and resilience. First, the study developed a spatially explicit agricultural vulnerability index for California derived from 22 climate, crop, land use, and socioeconomic variables. Results of the agricultural vulnerability index suggest that the Sacramento-San Joaquin Delta, the Salinas Valley, the corridor between Merced and Fresno, and the Imperial Valley merit special consideration due to their high agricultural vulnerability. The underlying factors contributing to vulnerability and resilience differ among these regions, indicating that future studies and responses could benefit from adopting a contextualized “place based” approach. As an example of this approach, the research team summarized the findings from a recent study on climate change adaptation in Yolo County. The Yolo County study consists of: (1) an econometric analysis of crop acreages under future climate change projections; (2) a hydrologic model of the Cache Creek watershed that simulates the impact of future climate and crop acreage projections on local water supplies; (3) a countywide inventory of agricultural greenhouse gas (GHG) emissions and how it might be used to inform local Climate Action Plans; (4) a survey of farmers’ views on climate change, its impacts and what adaptation and mitigation strategies they might be inclined to adopt; and (5) an urban growth model that evaluates various future development scenarios and the impact on Yolo County farmland and GHG emissions. Since farmland throughout the state is vulnerable to urbanization, the study also used urban growth projections for 2050 to examine the possible impacts on statewide agricultural production, land use patterns, and soils. Lastly, the study examined two on-farm case studies (Fetzer/Bonterra Vineyards and Dixon Ridge Farms) that highlight the possible benefits of innovative agricultural practices (for example, vineyard carbon storage and renewable energy production from crop residues) that link adaptation and mitigation.

Keywords: agriculture, vulnerability, adaptation, greenhouse gas mitigation, land use change, farmer perspectives, water resources, renewable energy

Please use the following citation for this paper:

Jackson, Louise, Van R. Haden, Stephen M. Wheeler, Allan D. Hollander, Josh Perlman, Toby O’Geen, Vishal K. Mehta, Victoria Clark, John Williams, and Ann Thrupp (University of California, Davis). 2012. **Vulnerability and Adaptation to Climate Change in California Agriculture**. California Energy Commission. Publication number: CEC-500-2012-031.

TABLE OF CONTENTS

Acknowledgements.....	i
Preface.....	iii
Abstract.....	iv
1.0 Introduction	1
1.1 References	2
2.0 An Agricultural Vulnerability Index for California.....	3
2.1 Introduction.....	3
2.2 Methods.....	4
2.2.1 Variables Used in the California Agricultural Vulnerability Index.....	4
2.2.2 Climate Vulnerability Sub-index	6
2.2.3 Crop Vulnerability Sub-index	7
2.2.4 Land Use Vulnerability Sub-index	7
2.2.5 Socioeconomic Vulnerability Sub-index.....	8
2.2.6 Statistical Analysis	9
2.3. Results and Discussion.....	10
2.3.1 Climate Vulnerability	10
2.3.2 Crop Vulnerability	12
2.2.3 Land Use Vulnerability	14
2.3.4 Socioeconomic Vulnerability	16
2.3.5 Total Agricultural Vulnerability Index.....	18
2.4. Future Directions for the California Agricultural Vulnerability Index.....	19
2.5 References	20
3.0 Agricultural Mitigation and Adaptation to Climate Change in Yolo County, California.....	26
3.1 Introduction to the Place-based Agriculture Adaptation Study	26
3.1.1 Yolo County: Background on Agriculture as Relevant to Climate Change	27
3.1.2 Previous Work on Climate Change Impacts on Yolo County Agriculture.....	27

3.2 Climate-induced Changes in Acreage of Crops in Yolo County Including Projections to 2050	30
3.3 Simulating the Effects of Climate Change and Adaptive Water Management on the Cache Creek Watershed: Alternative Agricultural Scenarios for a Local Irrigation District	35
3.4 Involving Local Agriculture in California’s Climate Change Policy: An Inventory of Agricultural Greenhouse Gas Emissions in Yolo County	38
3.5 Farmer Perceptions of Climate Change in Yolo County: What Drives their Inclination to Adopt Various Adaptation and Mitigation Practices?	42
3.6 Land Use Change, GHG Mitigation, Alternative Urban Growth Potential in Yolo County	45
3.8 Conclusions from the Yolo County Case Study	48
3.7 References	49
4.0 Urban Growth Scenarios, Land Use, and Farmland Loss	52
4.1 Introduction and Background on Urbanization of Farmland in California	52
4.2 Approach and Methods for Statewide Urbanization Scenarios	53
4.3 Results of Urbanization Scenarios on Farmland Loss.....	57
4.3.1 Quantities of Agricultural Land Lost to Urbanization by 2050	57
4.3.2 Areas of Class I and Class II Soils Lost to Urbanization by 2050	57
4.3.3 Agricultural Areas and Crops Particularly Affected by Urbanization	63
4.3.4 Implications of the Yolo County Example for Statewide Agriculture-Urbanization-Climate Change Analysis.....	70
4.5 Potential Policy Interventions	71
4.6 Conclusion	71
4.7 References	73
5.0 Carbon Stocks and Land Use in a Vineyard/Woodland Landscape: A Case Study of Fetzer Vineyards	76
5.1 Introduction: Carbon Assessment on Vineyard/Woodland Lands	76
5.2 Overview of the Fetzer/Bonterra Vineyard Study on Carbon Stocks.....	77
5.3 Implications and Future Directions.....	81
5.4 References	83

6.0 Investigating the Mitigation Potential of On-farm Renewable Energy in California: A Case Study of Dixon Ridge Farms	85
6.1 Introduction to On-farm Renewable Energy Project	85
6.2 Farm Description.....	86
6.3 Methods for LEAP Analysis	87
6.3.1 Model Structure and Data Sources	87
6.4 Results of the LEAP Analysis.....	93
6.4.1 Energy Demand and Benefits of Renewable Generation	93
6.4.2 Expansion of Renewable Generation (M1 Scenario).....	93
6.4.3 Enhanced Mitigation Facilitated by SB 489 (M2 Scenario).....	93
6.4 Discussion of On-farm Renewable Energy Projects.....	94
6.6 References	98

LIST OF FIGURES

Figure 2.1. Time Series of Northern California Temperature Projections from 39 AR4 Simulations with the Parallel Climate Model (PCM, left) and GFDL (right), with the Historical, B1, and A2 Simulations Analyzed Here Highlighted.....	6
Figure 2.2. Climate Vulnerability Sub-Index That Integrates Agriculturally Relevant Climate Variables Derived from GFDL Climate Model Data for California During the Recent 30-yr Historical Period. Vulnerability level is assigned based on standard deviation (SD).	11
Figure 2.3. Crop Vulnerability Sub-Index Which Integrates Variables for Crop Sensitivity, Crop Dominance and Pesticide Use throughout California. Vulnerability level is assigned based on standard deviation (SD).	13
Figure 2.4. Land Use Vulnerability Sub-Index Which Integrates Agriculturally Relevant Land Use Change and Land Quality Variables throughout California. Vulnerability level is assigned based on standard deviation (SD).	15
Figure 2.5. Socioeconomic Vulnerability Sub-Index Which Integrates Variables for the Number of Farm Workers, Disaster Payments, Percent Loss of Farms, Percent Loss of Farm Jobs, a Social Vulnerability Index, and Herfindahl Index throughout California. Unlike the other sub-indices, the socioeconomic sub-index was based entirely on county-level data. Vulnerability level is assigned based on standard deviation (SD).	17

Figure 2.6. Total Agricultural Vulnerability Index (AVI) Which Integrates the Four Sub-Indices for Climate Vulnerability, Crop Vulnerability, Land Use Vulnerability, and Socioeconomic Vulnerability. Vulnerability level is assigned based on standard deviation (SD)..... 19

Figure 3.1. Map of Yolo County, California, Showing Land Use Types. The Sacramento River is the eastern boundary of the county. The Coast Range Mountains extend north-south along the western edge..... 29

Figure 3.2. Historical Crop Acreage by Crop Category for Selected Years during 1950–2008 31

Figure 3.3. Historical Average Monthly Temperature (°f) for January and February Computed Using Daily Minimum and Maximum Temperatures for the Period of 1909–2008 for Davis, California..... 32

Figure 3.4. Wheat Acreage in Yolo County, in the Past and as Projected with an Econometric Model. The first half of the graph presents actual and projected acreage values in solid and dotted lines, respectively, and the second half presents projected acreage for the B1 and A2 scenarios for 2010–2050 using GFDL climate data. Crop acreages for 2008 were the starting point for the future modeling, and all other factors except climate were held constant until 2050. 34

Figure 3.5. Map of the Study Area Modeled Using WEAP. Colored polygons are independently characterized catchments. Hatched polygon is the Yolo County Flood Control and Water Conservation District..... 35

Figure 3.6. Difference in Projected Irrigation Demand for Three Adaptation Scenarios Relative to the Impact of Climate Alone (2009–2099). The B1 and A2 climate scenarios are derived from downscaled projections of the GFDL general circulation model. Adaptation 1 is based on land use projections derived from an econometric model for the 2009–2050 period. Adaptation 2 uses hypothetical land use projections, which assume a more diverse and water efficient cropping pattern. Adaptation 3 combines the diversified cropping pattern with a projected increase in irrigation technology adoption. 37

Figure 3.7. Urban Growth in Yolo County, 2010–2050, A2 Scenario, Detail of Cities 46

Figure 4.1. Urban Growth Analysis Areas Statewide. The regional boundaries are based on groups of counties that share similar geographical characteristics that are relevant to broad patterns urbanization and agricultural production. The boundaries are not meant to follow official regional jurisdictions, though in some cases they do coincide (e.g., the Sacramento Area Council of Governments [SACOG] region and the Association of Bay Area Governments [ABAG] region). 56

Figure 4.2. Urban Growth Statewide as Modeled by UPlan for BAU Scenario 58

Figure 4.3. Urban Growth Statewide as Modeled by UPlan for SG Scenario..... 59

Figure 4.4. 2050 Urban Growth Detail Map for the Lower San Joaquin Valley, BAU, and SG Scenarios..... 66

Figure 4.5. Urban Growth Detail Map for the Bay Area, BAU, and SG Scenarios 67

Figure 4.6. 2050 Urban Growth Detail Map for the Sacramento Area, BAU, and SG Scenarios ..	68
Figure 4.7. Urban Growth Detail Map for Southern California, BAU, and SG Scenarios	69
Figure 5.1. Study Site in Mendocino County, California (state shown in inset), with the Location of the Five Wine Grape-growing Ranches (labeled) Where Carbon Stocks Were Assessed for Vineyards and Adjoining Wildlands	79
Figure 5.2. Spatial Representation of Total Carbon Stocks in Aboveground Wood and Soil (to 1 m depth) for the Five Ranches Considered in this Study.....	80
Figure 6.1. Schematic of the Biomax Unit, Which Consists of a Feed Hopper, a Pyrolytic Gasifier, and an Internal Combustion (IC) Generator. During walnut drying operations, producer gas can be diverted from the generator and used as a substitute for propane.	87
Figure 6.2. Configuration of Demand Branches in LEAP	88
Figure 6.3. Percent Contribution of Energy Sources to Total Energy Demand in 2011 for Growing and Processing Walnuts at Dixon Ridge Farms under (A) BAU Scenario (total BAU demand = 14,019 GJ) and (B) REN Scenario (total REN demand = 13,913 GJ). Propane demand is displaced by producer gas (3,360 GJ) in the REN scenario. The small difference in energy demand between the scenarios is associated with avoided diesel for transporting walnut shell waste off-site.	95
Figure 6.4. Estimated GHG Emissions for the Business-as-Usual (BAU), Renewable Energy Generation (REN), Mitigation 1 (M1), and Mitigation 2 (M2) Scenarios in 2015.....	96
Figure 6.5. Amount and Source of Electricity (thousands of kWh) for the Business-as-Usual (BAU), Renewable Energy Generation (REN), Mitigation 1 (M1), and Mitigation 2 (M2) Scenarios in 2015	96
Figure 6.6. Electricity Generation Requirements by Source for the (a) Mitigation 1 Scenario (M1) and (b) Mitigation 2 Scenario (M2). Requirements for electricity grow in the M2 scenario as walnut processing increases, but a larger portion of the farm’s requirements can be met by the expanded electricity generation capacity due to three Biomax units.....	97

LIST OF TABLES

Table 2.1. Variables Used in the California Agricultural Vulnerability Index, Grouped by Sub-index.....	5
Table 2.2. Rotated Loading Values, Eigenvalues and Variance of PC1 and PC2 for the Variables That Are Included in the Climate Vulnerability Sub-index.....	10

Table 2.3. Rotated Loading Values, Eigenvalues and Variance of PC1 and PC2 for the Variables That Are Included in the Crop Vulnerability Sub-index.....	13
Table 2.4. Rotated Loading Values, Eigenvalues and Variance of PC1 and PC2 for the Variables That Are Included in the Land Use Vulnerability Sub-index.....	15
Table 2.5. Rotated Loading Values, Eigenvalues and Variance of PC1, PC2, and PC3 for the Variables in the Socioeconomic Vulnerability Sub-Index of the California Agricultural Vulnerability Index.....	17
Table 3.1. Summary of Yolo County Agricultural CO ₂ , N ₂ O, and CH ₄ emissions (kt CO ₂ e) for 1990 and 2008, by Source Category. Estimates were made using Tier 1 methods, activity data based on local agricultural practices, and default emission factors. For detailed methods see Jackson et al. (2012).....	40
Table 3.2. Cultivated Area, Production Input Rates and Estimated Emissions for Yolo County Crop Categories in 1990 and 2008. Estimated emissions for direct N ₂ O, indirect N ₂ O, and mobile farm equipment are based on Tier 1 inventory methods, local activity data, and default emission factors.....	41
Table 3.3. Perception of Past Trends in Local Summer Temperatures, Winter Temperatures, Annual Rainfall, Water Availability, Frequency of Drought, and Frequency of Flooding	43
Table 3.4. Regression Coefficients for Future Climate Impact Concerns (1 = very concerned, 4 = not concerned) and the Inclination to Use Various Practices to Adapt to Water Scarcity (1 = very likely to adopt, 5 = very unlikely to adopt)	44
Table 3.5. Summary of Specific Crops and Acres Lost to Urbanization under Each Storyline. Note that pasture refers to upland, non-irrigated grazing lands and savanna. Only forest, grassland, and pastures are typically non-irrigated.	47
Table 4.1. Previous and Future Uses of Farmland Areas Converted to Urban by 2050 under UPLAN Business as Usual Scenario. Agricultural, natural, and urban land use categories were derived from the California Augmented Multipurpose Landcover (CAML) geospatial database.	60
Table 4.2. Previous and Future Uses of Farmland Areas Converted to Urban by 2050 under Uplan Smart Growth Scenario. Agricultural, natural, and urban land use categories were derived from the California Augmented Multipurpose Landcover (CAML) geospatial database.	61
Table 4.3. Area Converted to Urban by 2050 under UPlan Business as Usual Scenario. The SSURGO soil dataset was used to determine land capability classes.	62
Table 4.4. Previous and Future Uses of Farmland Areas Converted to Urban by 2050 under UPLAN Smart Growth Scenario. The SSURGO soil dataset was used to determine land capability classes.	62

Table 4.5. Potential Policy Interventions to Manage Urbanization So as to Reduce Agricultural Vulnerability in the Context of Climate Change	72
Table 5.1. Per Hectare and per Ranch Results of Carbon Assessment Shown by Land Use Type (vineyard or wildlands) and by Carbon Reservoir Considered (i.e., Aboveground (AG) or Soil). For more detail, see Williams et al., in press).....	81
Table 6.1. Assumed Fuel Mix from Grid Electricity Supplied to Dixon Ridge Farm.....	89
Table 6.2. LEAP Branches and IPCC Tier 2 Emission Factors (EF) Expressed in kg of Gas Per Terajoules (TJ) of Energy for the Fuel Types Used at Dixon Ridge Farm.....	92

1.0 Introduction

California has been the top agricultural producer in the United States for more than 60 years; production in 2008 was 11.2 percent of the total U.S. value of agricultural crops and commodities (CDFA 2010). California supplies nearly half of the nation's fruits and vegetables. The value of gross agricultural cash receipts was \$36.2 billion in 2008, of which exports were 16 percent. Thus, agricultural vulnerabilities and adaptation to climate change in California are important to millions of people, many of whom know little or nothing about the state, its resources, or its agricultural sector.

To build public support for understanding agricultural adaptation to climate change and the need to mitigate greenhouse gas (GHG) emissions, it will be necessary to develop greater awareness of a broad set of biophysical and socioeconomic factors that influence agricultural sustainability (USDA 1990). Previous studies on impacts and adaptation to climate change in California have mainly focused on responses to abiotic factors such as water supply (Purkey et al. 2008) and increases in temperature (such as winter chill hours for fruit trees; Baldocchi and Wong [2008]). Social issues such as labor, markets, and policy for land use change need more attention in the context of climate change (Ikeme 2003; Farber 2011). Environmental issues and the provision of ecosystem services by agricultural lands also must be included in analyzing the tradeoffs of different types of adaptive strategies (Raudsepp-Hearne 2010; Brekke et al. 2009).

To address these issues, this project took several approaches to studying agricultural vulnerability and adaptation to climate change in California. We explored a wider conceptual framework for climate change responses than has been addressed for California agriculture in the past. Each approach is a stand-alone study that utilizes different types of methods, develops different types of adaptive capacity, and is relevant to different stakeholder groups. Rather than provide an integrated analysis, the main outcome shows the versatility of new formats for developing and synthesizing interdisciplinary information at multiple scales that can be useful in design of strategies for adaptation to climate change. This paper consists of the following sections:

- Assessment of dimensions of vulnerability that vary across the state's agricultural landscape, and design of an "Agricultural Vulnerability Index" (AVI) for California (Section 2)
- Summary of a case-study, "Adaptation Strategies for Agricultural Sustainability in Yolo County," (California Energy Commission 500-09-009) (Section 3)
- Implications of urbanization related to agriculture and climate change, based on statewide modeling of 2050 urban growth scenarios, and datasets on agricultural production, land use, and soils (Section 4)
- Examples of on-farm quantification GHG mitigation and their relevance to climate change adaptation in their farming operations (Fetzer/Bonterra Vineyards and Dixon Ridge Farms) (Section 5 and 6, respectively)

1.1 References

- Baldocchi, D., and S. Wong. 2008. "Accumulated winter chill is decreasing in the fruit growing regions of California." *Climatic Change* 87: 153–166.
- Brekke, L. D., J. E. Kiang, J. R. Olsen, R. S. Pulwarty, D. A. Raff, D. P. Turnipseed, R. S. Webb, and K. D. White. 2009. Climate change and water resources management—a federal perspective. U.S. Geological Survey Circular 1331, 65 p. Also available online at <http://pubs.usgs.gov/circ/1331/>.
- CDFA (California Department of Food and Agriculture). 2010. California Agricultural Highlights. Available at www.iscc.ca.gov.
- Farber, D. A. 2011. "The Challenge of Climate Change Adaptation: Learning from National Planning Efforts in Britain, China, and the USA." *Journal of Environmental Law*. UC Berkeley Public Law Research Paper No. 1789194. Available at SSRN: <http://ssrn.com/abstract=1789194>.
- Ikeme, J. 2003. "Equity, environmental justice and sustainability: incomplete approaches in climate change politics." *Global Environmental Change* 13(3) October 2003, :195–206.
- Purkey, D. R., B. Joyce, S. Vicuna, M. W. Hanemann, L. L. Dale, D. Yates, and J. A. Dracup. 2008. "Robust analysis of future climate change impacts on water for agriculture and other sectors: A case study in the Sacramento Valley." *Climatic Change* 87(1): S109–S122.
- Raudsepp-Hearne, C., G. D. Peterson, M. Tengö, E. M. Bennett, T. Holland, K. Benessaiah, G. K. MacDonald, and L. Pfeifer. 2010. "Untangling the Environmentalist's Paradox: Why Is Human Well-being Increasing as Ecosystem Services Degrade?" *BioScience* 60(8): 576–589. Available at <http://www.aibs.org/bioscience-press-releases/resources/Raudsepp-Hearne.pdf>.
- USDA. 1990. Public Law 101-624, Title XVI, Subtitle A, Section 1683. Available at <http://www.nal.usda.gov/afsic/pubs/terms/srb9902.shtml>.

2.0 An Agricultural Vulnerability Index for California

V. R. Haden, A. D. Hollander, J. Perlman, A. O'Geen, S. M. Wheeler, L. E Jackson

2.1 Introduction

Global environmental changes tend to have a disproportionate impact on agriculture compared to other parts of the economy. Since agriculture relies directly on natural resources, those who work in agriculture are inherently vulnerable to changes in climate, water availability, and land use (Leary et al. 2006; Bryan et al. 2009). Volatility in agricultural markets and the cost of energy, fertilizers, and other inputs are also major sources of concern among farmers (Jackson et al. 2012). Such changes can have a multitude of biophysical and social consequences that are often difficult to predict. While some farmers will anticipate changes and reap benefits, others will face increasing vulnerability unless efforts are made to strengthen their adaptive capacity and enhance the resilience of agricultural ecosystems (Liechenko and O'Brien 2002; Smit and Wandel 2006; Jackson et al. 2011).

Vulnerability, defined here as “the potential for loss,” is often assessed by examining biophysical and social indicators that reflect aspects of exposure, sensitivity and adaptive capacity, which vary over time and space (Adger 2006; Eakin and Luers 2006; Cutter et al. 2003). Given the orientation of vulnerability towards negative outcomes, it is also necessary to understand the factors that ensure resilience within social-ecological systems (Eakin and Luers 2006). Since vulnerability and resilience vary spatially, a number of recent studies have developed methods for mapping dimensions of vulnerability using geographic information systems. The Social Vulnerability Index (SOVI) is one approach that has been used to link social indicators with biophysical data and explore vulnerability to environmental hazards (Cutter et al. 2003; Cutter and Finch 2008). The body of work which uses the SOVI has compared changes in social vulnerability among U.S. counties over the last 40 years, and integrated social vulnerability with exposure to flood risks in the Sacramento-San Joaquin Delta (Burton and Cutter 2008; James and Cutter 2008). From a theoretical perspective, the SOVI has helped establish the “hazards of place” concept and provides a model for indentifying vulnerable regions and communities that merit closer examination through contextualized and place-based approaches (Cutter and Finch 2008; Cutter et al. 2009).

In the context of climate change vulnerability, O'Brien et al. (2000, 2004) use an indexing approach to highlight the “double exposure” of agricultural populations to the impacts of climate change and economic globalization. In their work, socioeconomic indices are superimposed on top of mapped climate data to illustrate spatial differences in vulnerability. They then use case studies, surveys and interviews to help interpret impacts on agricultural livelihoods in vulnerable locations. These studies and others, illustrate the need to balance large-scale spatial analysis of climate change and socioeconomic impacts with localized, often community-level, assessments of vulnerability and adaptive capacity (Adger 2004; Brooks et al. 2005).

Here we develop an Agricultural Vulnerability Index (AVI) for California that aims to integrate a broad set of biophysical and social indicators that are relevant to state and local efforts to adapt to changes in climate, land use and economic forces. Given its geographic heterogeneity and diverse agricultural economy, California offers a prime opportunity to examine spatial differences in agricultural vulnerability, as well as the responses that will be needed to adapt successfully. A second objective of this study is to identify regions of concern, which may require a more careful assessment of local impacts and adaptive responses by stakeholders in the agricultural community. In essence, the California AVI is meant to be a starting point for “place-based” adaptation planning throughout California, perhaps patterned on an early example from Yolo County summarized in Section 3 of this paper (Jackson et al. 2012).

2.2 Methods

2.2.1 Variables Used in the California Agricultural Vulnerability Index

The California AVI developed in this study is based on 22 biophysical and social variables, collected to assess dimensions of vulnerability which vary across the state’s agricultural landscape. Each variable was assigned to one of four sub-indices (e.g., climate vulnerability, crop vulnerability, land use vulnerability, and socioeconomic vulnerability) based on two criteria: (1) an a priori judgment of which variables are most relevant to a given vulnerability sub-index; and (2) a consideration of the spatial resolution at which the data are available (Table 2.1). For example, the climate, crop, and land use sub-indices use data available at a relatively fine spatial resolution, while the variables assigned to the socioeconomic sub-index are all based on county-level data. To facilitate subsequent statistical analysis all variables were standardized to represent percentages, index values, densities or area weighted averages for a 12.5 square kilometer (km²) raster grid covering the entire extent of California’s land area (2,628 total grid cells). Hereafter, whenever the term “grid cell” is used it refers to smallest unit of analysis within the study’s standardized 12.5 km² grid. While 2000 was the target time frame for this study, the availability of certain data types in some instances required the use of data covering periods immediately before or after 2000.

Table 2.1. Variables Used in the California Agricultural Vulnerability Index, Grouped by Sub-index

Sub-index	Variable	Unit Mapped
Climate Vulnerability ¹	Lowest annual temperature	Average lowest temperature °C, 1981–2009
	Days above 30°C (86°F)	Average annual days, 1981–2009
	Days in July above 35°C (95°F)	Average annual days, 1981–2009
	Days in growing season	Average annual days, 1981–2009
	Chill hours	Average annual hours, 1981–2009
	Precipitation	Average annual mm , 1981–2009
	CV precipitation	Percent variance, 1981–2009
	Potential evapotranspiration	Average annual mm ,1971–1999
Crop Vulnerability	Crop climate sensitivity index	Area weighted average index value
	Crop dominance index (Simpson)	Area weighted average index value
	Pesticide application rate	kg of pesticide per km ²
Land Vulnerability	% Land area in cropland	Percent of area in each grid cell
	Storie index	Area weighted average index value
	% Land area converted to urban	Percent of area in each grid cell, 1991–2000
	Soil salinity (electrical conductivity)	Area and depth weighted average dS m ⁻¹
	% Land area in 100-year flood plain	Percent of area in each grid cell
Socioeconomic Vulnerability	Social vulnerability index	County-level index value, 2000
	% Loss of farm jobs from 1999–2009	County-level percent
	Seasonal and migrant farm workers	Workers per km ² of cropland in county, 2000
	Farm disaster payments from 1995–2010	Dollars per km ² of cropland in county
	% Loss of farms from 2002–2007	County- level percent
	Commodity concentration (Herfindahl index)	County-level index value, 2002

¹Historical climate data calculated from Geophysical Fluid Dynamics Laboratory (GFDL) climate model output downscaled using the bias corrected constructed analog method.

2.2.2 Climate Vulnerability Sub-index

Exposure to adverse climatic conditions is an important aspect of agricultural vulnerability. Downscaled daily climate data from a general circulation model (GFDL CM2.1) produced by the National Oceanic and Atmospheric Administration (NOAA) Geophysical Fluid Dynamics Laboratory was used to generate a series of seven annual climate variables averaged over the past 30 years (1981–2010) (Delworth et al. 2006; Knutson et al. 2006). The GFDL model, as seen in Figure 2.1, has been found to produce a reasonable representation of California’s recent historical climate, as well as the spatial distribution of temperature and precipitation within the region (Cayan et al. 2008). For these data, the Bias Corrected Constructed Analog (BCCA) method was used for downscaling, due to its superiority amongst other methods (Maurer et al. 2010). The annual variables included: lowest minimum temperature, days above 30°C (86°F), days in July above 35°C (95°F), days in the growing season, chill hours, precipitation and the coefficient of variation of precipitation. These data were originally available on a latitude-longitude basis with 1/8th degree cells which were reprojected onto a standard grid with a 12.5 km² resolution using the California Teale Albers projection (EPSG:3310). This 12.5 km² standard grid was used for all subsequent analysis. An additional variable for potential evapotranspiration (PET), derived from monthly GFDL data for the 1971–2000 period was also included (Thorne et al. 2012). Since PET was available at a resolution of 270 square meters (m²), an average value was calculated for each cell in the standard 12.5 km² grid.

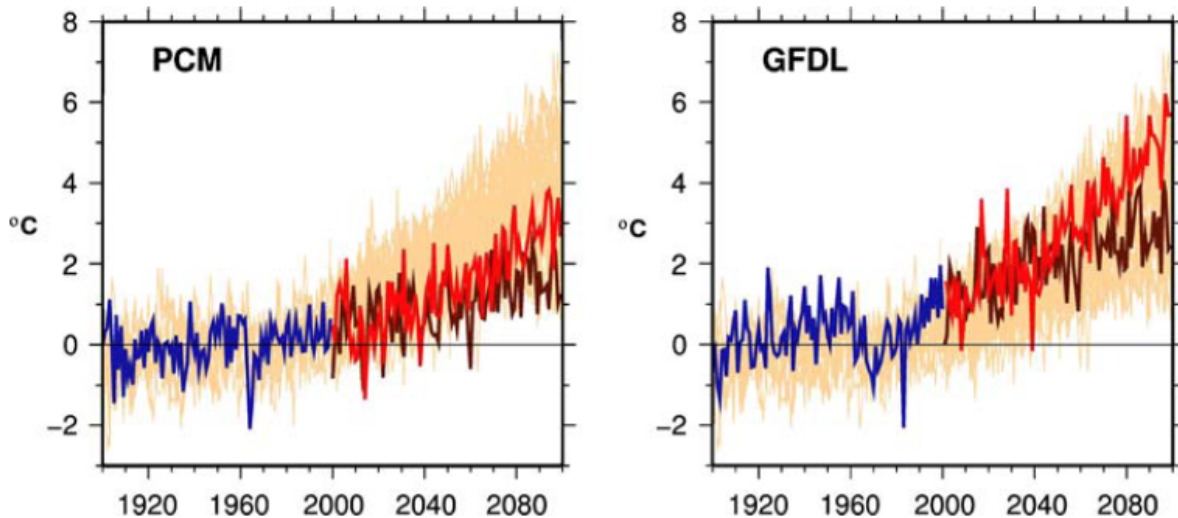

Figure 2.1. Time Series of Northern California Temperature Projections from 39 AR4 Simulations with the Parallel Climate Model (PCM, left) and GFDL (right), with the Historical, B1, and A2 Simulations Analyzed Here Highlighted

Source: Cayan et al., 2008.

2.2.3 Crop Vulnerability Sub-index

Different crops can vary widely in their sensitivity to climate, land characteristics, and agricultural markets. Crops with a small cultivated area are often more vulnerable since many are restricted by a narrow range of climatic conditions, low market demand, and/or heavy reliance on nearby processing facilities. Based on this rationale, a simple crop sensitivity index was developed for a roster of 72 crop categories mapped in the California Augmented Multi-purpose Land-cover (CAML) dataset (Hollander 2007). An index value between zero and one was calculated for each crop based on its total statewide area, where the least sensitive crop (i.e., the crop with the highest area) was scaled to zero and the most sensitive crop (i.e., the crop with the least area) was scaled to 1. Using these crop sensitivity index values, an area-weighted average inclusive of all crops in each 12.5 km² grid cell was calculated. In cases where a grid cell or county had no crops upon which to calculate the index, a value of zero was assigned. This was justified on the grounds that if no crops are present then the agricultural vulnerability would be inherently low.

Agricultural landscapes dominated by a small number of crop species tend to be more vulnerable to change than highly diversified systems. High levels of agrobiodiversity can often provide opportunities to spread risk and adapt to changes in climate and market by shifting to new crops (Smit and Skinner 2002; O'Farrell and Anderson 2010). This dimension of vulnerability was captured by calculating the Simpson dominance index (D) for crops (Eq. 1) (Simpson 1949).

$$D = \sum p_i^2 \quad \text{Eq.1}$$

In the equation, p represents the proportion of cropland area of the i th crop category in each grid cell. The CAML dataset described above was used to determine the spatial extent of each crop category within each grid cell (Hollander 2007). Since the CAML dataset does not distinguish rangeland from natural habitats, this agricultural category it was not considered. However, several irrigated pasture categories were included in the "cropland" classification. In the crop dominance index, high values indicate high dominance and high vulnerability, while low values imply more diversity and lower vulnerability. Based on the same justification mentioned above, grid cells that had no crops were assigned a value of zero.

The risk of crop losses from pest and disease are an important vulnerability for agricultural producers. As a proxy for pest pressure, we used pesticide use rates contained in the CAML spatial database, which allowed us to sum the total weight of pesticides applied for each grid cell (Hollander 2007).

2.2.4 Land Use Vulnerability Sub-index

Agricultural vulnerability is closely linked with the extent of land in agriculture, as well as its productive capacity. The assumption here is that areas with a greater fraction of land in crops have higher agricultural vulnerability than land that is mostly in natural habitat or urban land uses. We generated a variable for this by using the statewide CAML dataset to calculate the percent area in cropland within each 12.5 km² grid cell (Hollander 2007). Since higher-revenue-

per-area crops tend to be grown on more productive and higher quality soils, abrupt changes in market, urbanization, and weather can often lead to higher economic losses—that is, with higher potential returns there is more potential income at risk. The Storie index is a common method for characterizing the productive capacity of a soil for agricultural purposes based on a range of soil physical and chemical properties (Storie 1978). Thus, we calculated the weighted average of the Storie index value for each grid cell using a raster version of the USDA-SSURGO¹ soil dataset. Since agricultural land values are generally dwarfed by residential land values, farmland is vulnerable to urbanization in fast-growing peri-urban areas. As such, we included a variable for the fraction of land area converted to urban land use (within each grid cell) between 1992 and 2001, using land cover change maps in the National Land Cover Database (NLCD) from the U.S. Geological Survey (Fry et al. 2009). Various hydro-geologic characteristics of California’s landscape, such as flooding and soil salinity pose specific risks to agriculture (James and Cutter 2008; Backlund and Hoppes 1984). Flood risk was integrated into the land use sub-index by calculating the fraction of land area in the 100-year floodplain for each grid cell using the Q3 digital flood data available from the Federal Emergency Management Agency (FEMA 2008). Soil salinity in each grid cell was represented using an area weighted average of electrical conductivity (dS m^{-1}) from a raster version of the SSURGO soil dataset.

2.2.5 Socioeconomic Vulnerability Sub-index

Adverse changes in climate, land use, and agricultural markets tend to have a disproportionate impact on people of low socioeconomic status, particularly those employed by agriculture (Bryan et al. 2009). As such, we included a social vulnerability index (SOVI) variable, which integrates 42 social variables from the U.S. Census into a single index and compares county-level differences in social vulnerability to environmental hazards (Cutter et al. 2003; Cutter and Finch 2008). The SOVI values used in this study were obtained for the 2000 census year from a public website that provides access to the methodology and data used in these earlier studies (Cutter and Finch 2008). As another measure of socioeconomic vulnerability, we also calculated the number of seasonal and migrant farm workers per unit of cropland for each county. This variable was determined using county-level seasonal and migrant farm worker estimates reported by Larson (2000), which were divided by the area of cropland in each county. County cropland area was extracted from the aforementioned CAML dataset (Hollander 2007). In addition, county-level employment records from the California Employment Development Department were used to calculate a variable for the percent loss of farm jobs between 1999 and 2009 (CEDD 2010).

Farms adversely impacted by unfavorable weather or natural disasters are likely to request more government assistance in the form of farm disaster payments. Thus, we calculated a variable for farm disaster payments made to each county between 1995 and 2010 expressed on a cropland area basis using the CAML dataset (Hollander, unpublished). The county-level data on disaster payments are from U.S. Department of Agriculture records covering the full roster

¹ United States Department of Agriculture Soil Survey Geographic Database

of federal farm disaster programs (EWG 2011). Vulnerable farms are also more likely to go out of business, therefore we included a variable for the percent loss of farms in each county calculated using U.S. census of agriculture records for 2002 and 2007 (NASS 2002, 2007). Studies have also suggested that highly concentrated agricultural economies, as measured by the Herfindahl-Hirschman index (H), may be more vulnerable and less resilient to economic and climate-related changes than more diversified agricultural economies (Hirschman 1964; Kingwell 2006; Heltberg and Bonch-Osmolovskiy 2011). In this particular study, H is calculated for each county as the sum of the squares of market shares among 18 crop and livestock product categories reported in the 2002 U.S. Census of Agriculture (Eq. 2).

$$H = \sum s_i^2 \quad \text{Eq. 2}$$

In this equation, S_i equals the market share expressed as a proportion of the county's total agricultural sales for the i th product category. In this form, the Herfindahl-Hirschman index is mathematically equivalent to the Simpson dominance index (D) calculated above for crops. Thus, counties with highly concentrated agricultural economies, as indicated by high index values, are assumed to be more vulnerable.

2.2.6 Statistical Analysis

A principal component analysis (PCA) was conducted on the variables in each of the four sub-indices (i.e., climate vulnerability, crop and livestock vulnerability, land use vulnerability, and socioeconomic vulnerability). This was done to examine the covariance structure of the variables in each sub-index and facilitate subsequent compilation of the overall agricultural vulnerability index. Each variable was standardized to have a mean of zero and a standard deviation of one. Principal components (PC) with eigenvalues greater than one were retained, since these satisfied the Kaiser criterion (Kaiser 1960). A varimax rotation was then applied to the retained components. Each variable with a rotated loading greater than ± 0.5 was assigned to the principal component where it had the highest loading value. Communalities were used to estimate the proportion of variance for each variable explained by the retained components. The variable loadings were examined to ensure that the direction of the components (i.e., positive or negative) were all consistent, specifically that positive loadings for a variable were indicative of high vulnerability. If the directionality of the component was contrary to this logic, the rotated component scores were multiplied by negative one to reverse the direction but retain the covariance structure (Cutter 2003; Burton and Cutter 2008). If the variables that loaded on a component axis were ambiguous in relation to vulnerability, the component was not used in the sub-index calculation (e.g., see explanation of the results for PC2 in the climate sub-index). The rotated component scores for each grid cell were then summed to determine the sub-index value. Finally, the four sub-index values for each grid cell were added together to generate a value for the overall agricultural vulnerability index. Data for the sub-index and overall index values are mapped according to seven vulnerability levels (e.g., very high, high, moderately high, normal, moderately low, low, very low) based on the standard deviation (SD) around the mean.

2.3. Results and Discussion

2.3.1 Climate Vulnerability

In the climate vulnerability sub-index, eight initial variables were reduced to two retained components that explained 85.2 percent of the variance among grid cells (Table 2.2). Annual precipitation had a high negative loading on PC1, while potential evapotranspiration, climate vulnerability (CV) precipitation, days in July above 35°C (95°F), and days above 30°C (86°F) all had high positive loadings. This component effectively characterizes statewide patterns in precipitation and summer temperature. In contrast, the variables in PC2 reflect patterns in winter temperature with high positive values for both lowest minimum temperature and days in the growing season and high negative values for chill hours. The inverse relationship between chill hours and the other two variables in PC2, while intuitive, made it impossible to assign an unambiguous direction to the component in relation to vulnerability. For example, while warmer winter temperatures may result in inadequate chill hours for many orchard and vineyard crops, they can also reduce the incidence of freezing temperatures and expand the growing season for other crops (Baldochi and Wong 2008; Ludeling et al. 2009). Due to the ambiguity of PC2 in relation to vulnerability, only PC1 was used in the sub-index. The fact that PC1 accounted for 69.3 percent of the cumulative variance, confirmed that dropping PC2 would not reduce the amount of variance explained to levels below what is captured by the other sub-indices, which ranged between 84.0 and 67.0 percent (Table 2.3, Table 2.4, Table 2.5).

The spatial distribution of the sub-index values indicates moderately high and high climate vulnerability throughout the southeastern part of the state (Figure 2.2). The small total amount and high variability of precipitation combined with high summer temperatures and high potential evapotranspiration present more severe challenges to agriculture in southern California than in other parts of the state.

Table 2.2. Rotated Loading Values, Eigenvalues and Variance of PC1 and PC2 for the Variables That Are Included in the Climate Vulnerability Sub-index

Sub-index	Rotated Loading Values by Variable*	PC1	PC2	Communality
Climate Vulnerability	Potential evapotranspiration	0.82	0.51	0.93
	CV precipitation	0.78	0.20	0.65
	Days in July above 35°C (95°F)	0.75	0.42	0.74
	Days above 30°C (86°F)	0.75	0.45	0.77
	Annual precipitation	-0.89	-0.08	0.80
	Lowest minimum temperature	0.17	0.97	0.98
	Days in growing season	0.31	0.93	0.96
	Chill hours	-0.41	-0.90	0.97
	Eigenvalue	5.54	1.27	
	PC variance %	69.3	15.9	
	Cumulative variance %	69.3	85.2	

*Each variable with a rotated factor loading greater than ± 0.5 was assigned to the PC where it had the highest loading value among retained components.

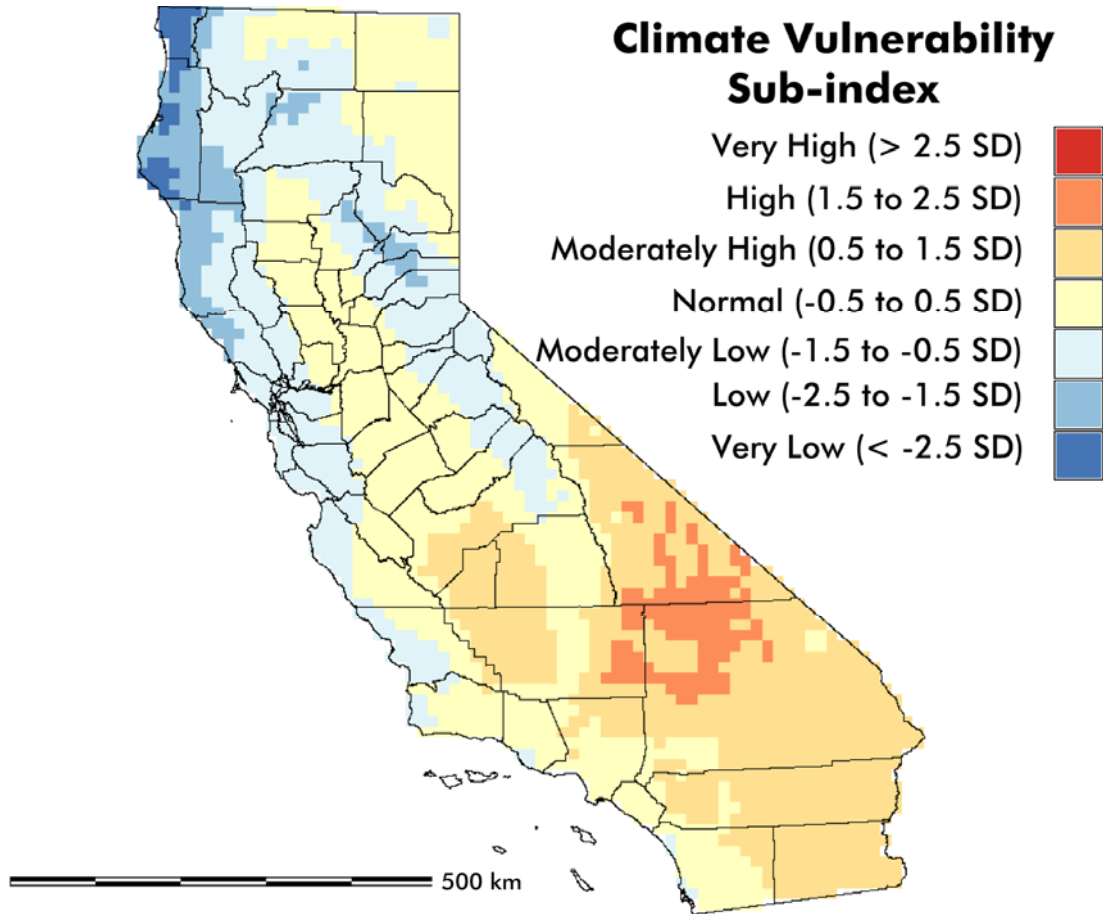

Figure 2.2. Climate Vulnerability Sub-Index That Integrates Agriculturally Relevant Climate Variables Derived from GFDL Climate Model Data for California During the Recent 30-yr Historical Period. Vulnerability level is assigned based on standard deviation (SD).

In particular, parts of San Bernardino, Kern, and Inyo counties tended to have the highest levels of climate vulnerability, though it should be noted that few crops are currently grown in the most vulnerable areas. As such, the primary agricultural regions of Kings, Kern, Riverside, and Imperial counties that have moderately high climate vulnerability merit closer consideration.

While a consensus has yet to be reached on how precipitation will change over the next century throughout California, there is broad agreement that temperature and potential evapotranspiration will generally rise (Brekke et al. 2008; Cayan et al. 2008; Gleick et al. 2000). Such changes will have a profound effect on regional hydrology, in many cases reducing the availability of surface and ground water while increasing irrigation demand (Purkey et al. 2008; Joyce et al. 2009). Strategies to safeguard supplies and minimize irrigation demand include expanding storage infrastructure, water pricing and markets, conjunctive use, groundwater banking, allocation limits, improved water use efficiency, public and private incentives for irrigation technology, reuse of tail-water, shifting to less water-intensive crops, and fallowing (Tanaka et al. 2006; California Roundtable on Water and Food Supply 2011). Even when water is

not limiting, high summer temperatures can have direct impacts on the yield of many crop species, particularly if extreme temperatures occur at key points during the reproductive phase (Hatfield et al. 2008). Since exposure to high temperatures is difficult to avoid in the field, adaptation strategies may require shifting to new crops or varieties with better tolerance to high temperatures (Jackson et al. 2009). Place-based adaptation plans at the county or irrigation district scale would provide opportunities to better understand the local risks and uncertainties; improve communication among stakeholders, officials and scientists; and ultimately enhance the community's capacity to adapt (O'Conner et al. 2001; Kiparsky and Gleick 2003; Dow et al. 2007).

2.3.2 Crop Vulnerability

For the crop vulnerability sub-index, two retained components cumulatively accounted for 86.3 percent of the variance among grid cells (Table 2.3). The crop dominance and crop sensitivity indices had high positive loadings on PC1, while pesticide rate had a very high positive loading on PC2. The Salinas and Santa Maria Valleys, as well as the areas surrounding Fresno and Bakersfield, had very high crop vulnerability due to a combination of high crop sensitivity and high pesticide use (Figure 2.3). Much of the Central Valley had moderately high vulnerability due to a mix of moderate crop sensitivity and moderate pesticide use. While Napa, Sonoma, Marin, and Mendocino counties had relatively low crop sensitivity due to the widespread cultivation of wine grapes, parts of these counties also had moderately high vulnerability due to high crop dominance (i.e., low diversity).

Changes in climate can directly impact crop growth through new temperature regimes and a northward shift in the range of pests and disease. In response to a reduction in chill hours, nut and stonefruit growers may require new low-chill hour varieties or a shift to new crops (Baldochi and Wong 2008). Warmer winter temperatures may extend the growing season for alfalfa or certain cool season crops (e.g., lettuce), and expand the range of subtropical crops like citrus. Warmer summer temperatures may allow for the cultivation of hot-season crops (e.g., melons, sweet potato) in regions where they are not currently grown (Jackson et al. 2009). Longer growing seasons will likely enable pest species to complete more reproductive cycles, which can increase the severity of infestations (Bale 2002). Improving agrobiodiversity can limit some of these risks by serving as a repository of germplasm for future plant breeding efforts, and providing specialized knowledge that may help growers shift more easily to new crops (Smit and Skinner 2002; O'Farrell and Anderson 2010; Jackson et al. 2010).

Table 2.3. Rotated Loading Values, Eigenvalues and Variance of PC1 and PC2 for the Variables That Are Included in the Crop Vulnerability Sub-index

Sub-index	Rotated loading values by variable*	PC1	PC2	Communality
Crop Vulnerability	Crop dominance index (Simpson)	0.92	-0.10	0.85
	Crop Sensitivity index	0.80	0.38	0.79
	Pesticide rate	0.07	0.97	0.95
	Eigenvalue	1.49	1.10	
	PC variance %	49.6	36.6	
	Cumulative variance %	49.6	86.3	

*Each variable with a rotated factor loading greater than ± 0.5 was assigned to the PC where it had the highest loading value among retained components.

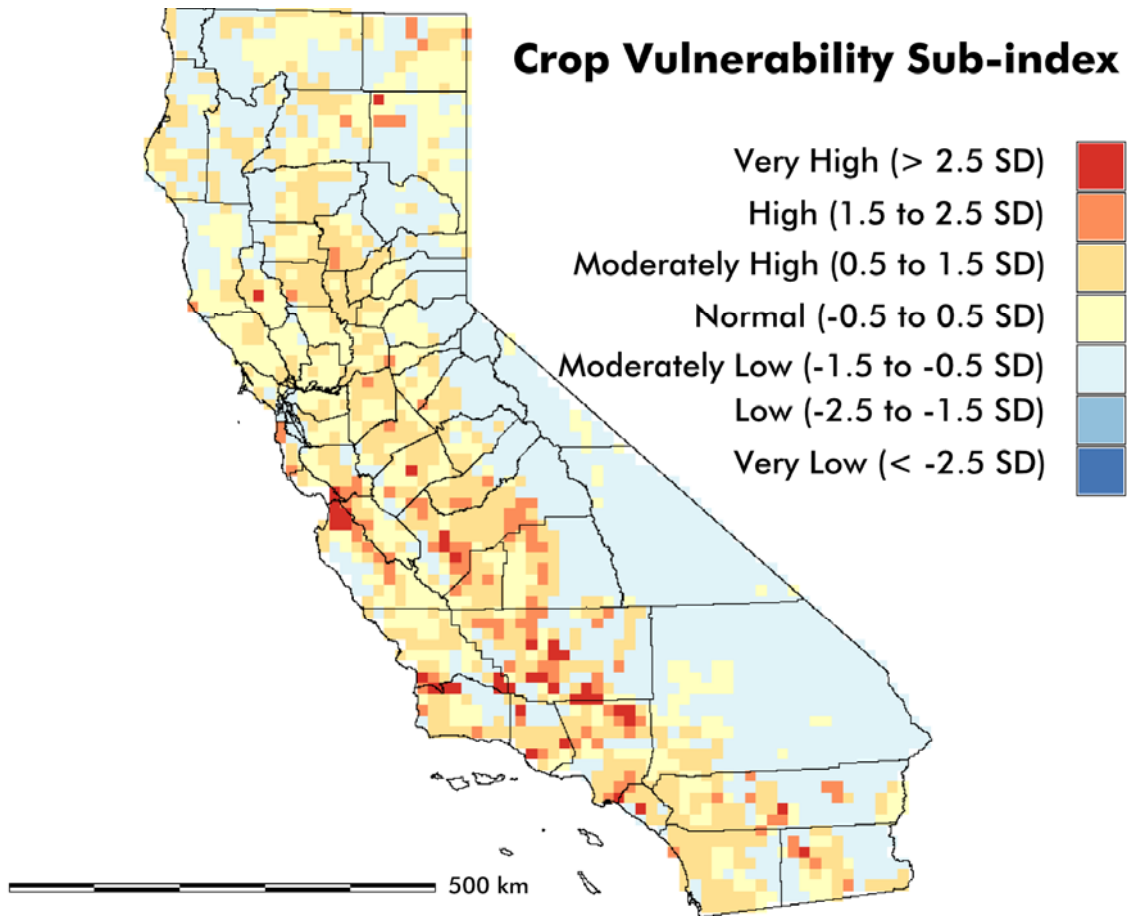

Figure 2.3. Crop Vulnerability Sub-Index Which Integrates Variables for Crop Sensitivity, Crop Dominance and Pesticide Use throughout California. Vulnerability level is assigned based on standard deviation (SD).

2.2.3 Land Use Vulnerability

Results of the PCA for the land use vulnerability sub-index indicate that 67.0 percent of the cumulative variance among grid cells is explained with two principal components (Table 2.4). Of the five initial variables, the fraction of land in cropland, the soil Storie index, and the land fraction converted to urban had high positive loading values on PC1. The close relationship between these variables is consistent with other studies that show high rates of urbanization on some of the highest quality cropland in the state (Jackson et al. 2012). Soil salinity and the fraction of land in the 100-yr floodplain had high positive loadings on PC2. Figure 2.4 shows the spatial distribution of land use vulnerability throughout California as measured by the sub-index. While relatively high land use vulnerability occurs throughout the Central Valley, areas of particular concern are the Sacramento-San Joaquin Delta, and the corridor between the Sacramento and Fresno. In these areas of rapid change from agricultural to urban land uses, sub-index values were frequently > 2.5 standard deviations above the mean. In the Delta region, the high vulnerability was largely due to the risks posed by both urbanization and flooding on highly productive agricultural soils. In contrast, a combination of increasing urbanization and high soil salinity were the important drivers of vulnerability further south in the San Joaquin Valley.

Conversion of prime farmland to urban uses is essentially a permanent loss of agricultural potential, with many consequences for agricultural livelihoods and society at large. When urban development fragments agricultural land, farmers often lose the benefits associated with being part of an integrated farming economy; for example, sources for inputs, information sources, and processing facilities (Porter 1998). Farming activities occurring along the urban edge can raise concerns about noise, odor, dust, and spray drift among new suburban residents, while vandalism of farm fields can cause problems for farmers (Lisansky 1986; Sokolow et al. 2010). Regional and local strategies to preserve farmland and manage urban growth include strengthening agricultural zoning policies, acquisition of conservation easements on farmland, establishment of urban growth boundaries, and prioritizing infill development (Jackson et al. 2012; see Section 3 of this paper). Given that greenhouse gas emissions from urban land can be more than 70 times greater per unit area than cropland (Haden et al., ms. submitted), policies that preserve agricultural land will also help achieve the mitigation targets set by California's recent suite of climate policies, namely AB 32² and SB 375.³

While the risks of flooding and soil salinization are not new to California farmers, they are likely to be exacerbated by climate change. Declining snow water storage in the Sierra Nevada is expected to increase the frequency and severity of flooding in the Central Valley (Tanaka et al. 2006; James and Cutter 2008). As such, efforts to help regional and district water resource managers develop accurate flood forecasts and flexible reservoir operations will further improve adaptive capacity (Yao and Georgakakos 2001).

² Assembly Bill 32 (Nuñez), Chapter 488, Statutes of 2006.

³ Senate Bill 375, Steinberg, Chapter 728, Statutes of 2008.

Table 2.4. Rotated Loading Values, Eigenvalues and Variance of PC1 and PC2 for the Variables That Are Included in the Land Use Vulnerability Sub-index

Sub-index	Rotated loading values by variable*	PC1	PC2	Communality
Land Use Vulnerability	Land area in cropland	0.87	0.29	0.83
	Storie index	0.84	0.16	0.72
	Land area converted to urban	0.65	-0.28	0.50
	Soil salinity	-0.11	0.81	0.68
	Land in 100y floodplain	0.41	0.66	0.61
Eigenvalue		2.22	1.13	
PC variance %		44.4	22.6	
Cumulative variance %		44.4	67.0	

*Each variable with a rotated factor loading greater than ± 0.5 was assigned to the PC where it had the highest loading value among retained components.

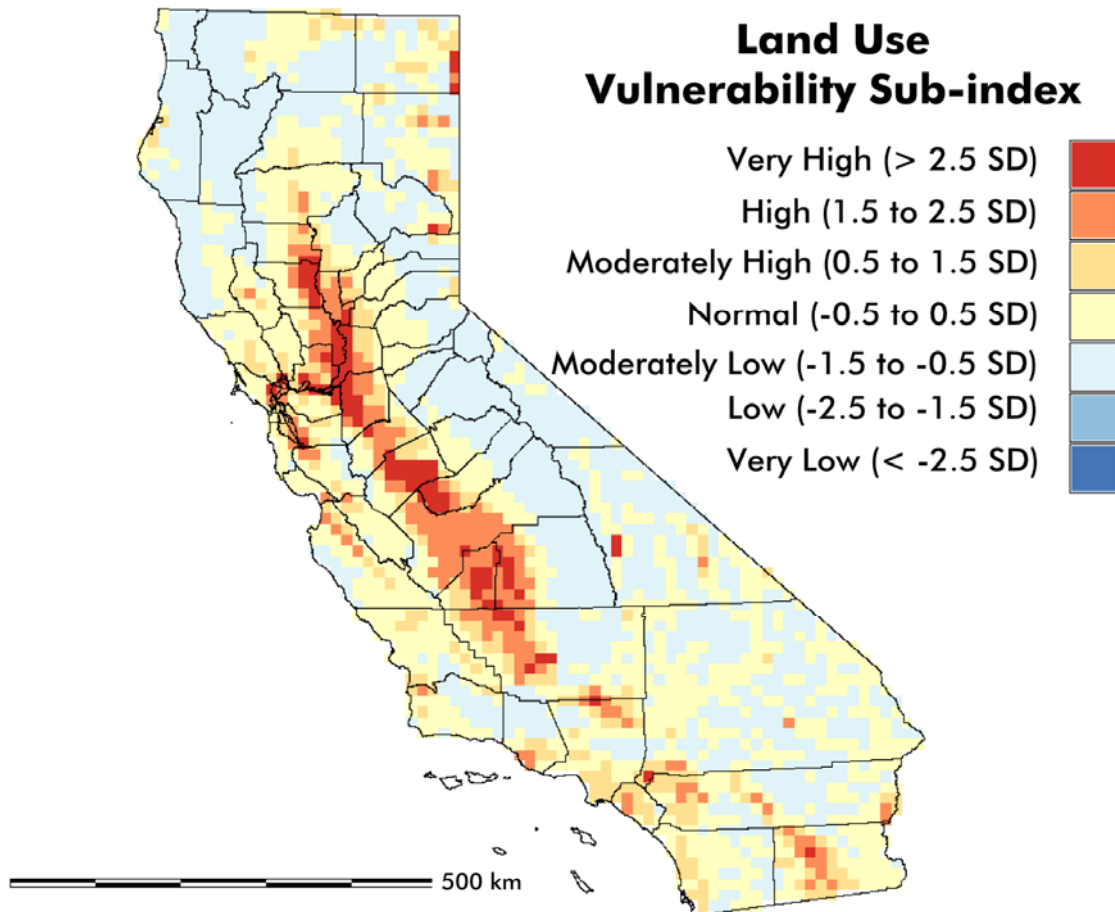

Figure 2.4. Land Use Vulnerability Sub-Index Which Integrates Agriculturally Relevant Land Use Change and Land Quality Variables throughout California. Vulnerability level is assigned based on standard deviation (SD).

More than 3 million acres of irrigated farmland in California have soils with an electrical conductivity above 4 dS m^{-1} , a standard threshold for the occurrence of agricultural impacts (Backlund and Hoppes 1984). Of the acreage affected, more than two-thirds is located in the San Joaquin Valley. In these areas, various irrigation methods can be used to leach salts out of the crop's rooting zone (Hanson et al. 2008). But since salts can still accumulate along the margins of the wetted area, growers must often apply water in excess of crop needs to ensure that salts are sufficiently leached (Hanson and May 2004). The installation of systems to drain, reuse, and dispose of saline effluent are also options, though high costs and a lack of suitable disposal sites remain important barriers (Backlund and Hoppes 1984; Grattan et al. 2002).

2.3.4 Socioeconomic Vulnerability

Results of the PCA for the socioeconomic vulnerability sub-index indicate that 70.3 percent of the cumulative variance among grid cells is accounted for by retaining three principal components (Table 2.5). Seasonal and migrant farm workers, loss of farms, and farm disaster payments all had high positive loadings on PC1, while loss of farm jobs and the social vulnerability index loaded highly on PC2. The commodity concentration (Herfindahl index) was largely independent of these other factors, as indicated by its high positive loading on PC3.

Three counties along California's Central Coast (San Mateo, Santa Cruz, San Benito) all had socioeconomic sub-index values greater than 1.5 standard deviations above the mean (Figure 2.5). The high vulnerability of these counties was due to two main factors: (1) the high rate of disaster payments per unit of cropland; and (2) the large number of seasonal and migrant farm workers per unit of cropland. A closer look at the agriculture in these counties reveals that while each have only a small amount of cropland, the mild coastal climate allows them to devote a large fraction to vegetable and berry crops. Since these tend to be high-value crops that require more labor, it follows that disaster payments and the number farm workers per unit of cropland area are also higher. Larger counties such as Monterey, San Joaquin, Imperial, and San Bernardino had moderately high socioeconomic vulnerability (i.e., between 0.5 and 1.5 standard deviations above the statewide mean) due to some of the same factors. In Yuba, Sutter, and Madera counties vulnerability was driven by a combination of high disaster payments and a loss of farm jobs. The main factor influencing the high vulnerability in Mendocino County and the moderately high vulnerability in Napa and Sonoma counties was their high Herfindahl index values, which captured the heavy concentration of wine grape production in this region.

Table 2.5. Rotated Loading Values, Eigenvalues and Variance of PC1, PC2, and PC3 for the Variables in the Socioeconomic Vulnerability Sub-Index of the California Agricultural Vulnerability Index

Sub-index	Rotated loading values by variable*	PC1	PC2	PC3	Communality
Socioeconomic Vulnerability	Seasonal/migrant workers	0.71	-0.01	-0.01	0.51
	Loss of farms	0.68	0.10	-0.18	0.50
	Disaster payments	0.62	-0.41	0.28	0.63
	Social vulnerability index	0.05	0.82	-0.10	0.85
	Loss of farm jobs	-0.44	0.75	0.16	0.78
	Commodity concentration (Herfindahl index)	-0.06	0.02	0.96	0.93
Eigenvalue		1.82	1.39	1.01	
PC variance %		30.3	23.1	16.9	
Cumulative variance %		30.3	53.4	70.3	

*Each variable with a rotated factor loading greater than ± 0.5 was assigned to the PC where it had the highest loading value among retained components.

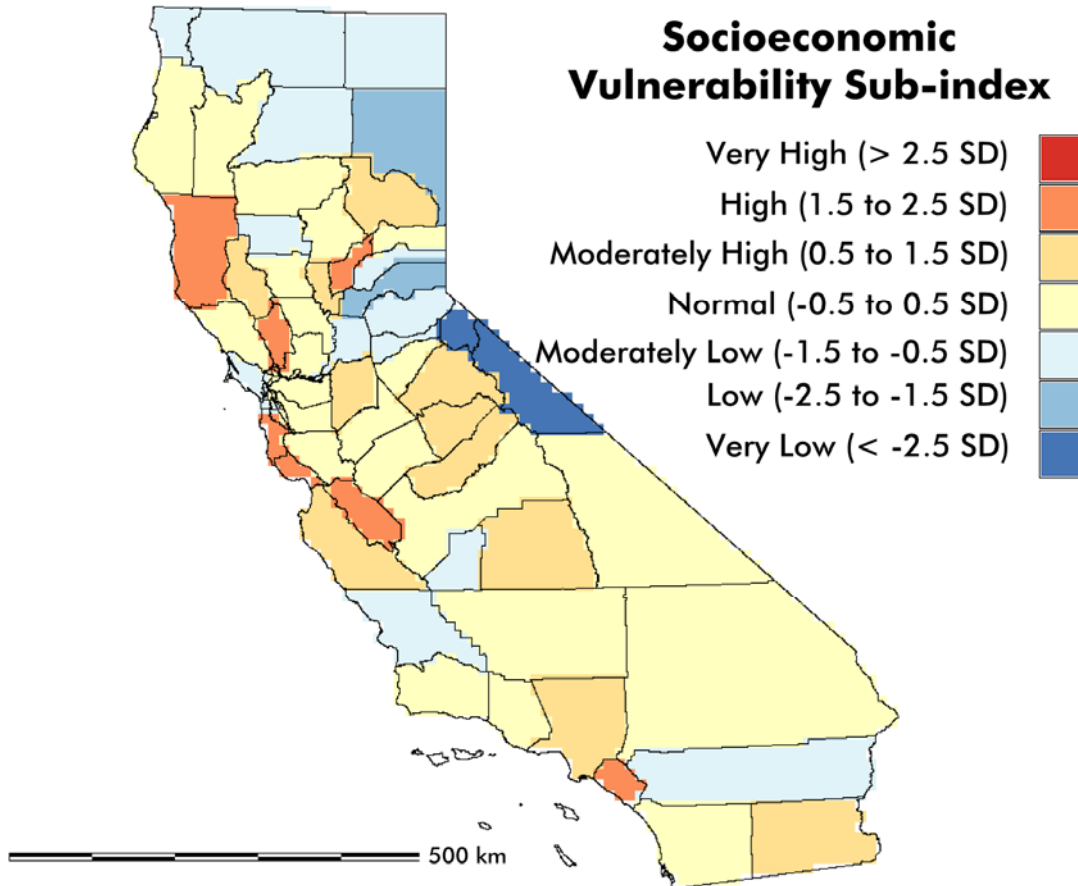

Figure 2.5. Socioeconomic Vulnerability Sub-Index Which Integrates Variables for the Number of Farm Workers, Disaster Payments, Percent Loss of Farms, Percent Loss of Farm Jobs, a Social Vulnerability Index, and Herfindahl Index throughout California. Unlike the other sub-indices, the socioeconomic sub-index was based entirely on county-level data. Vulnerability level is assigned based on standard deviation (SD).

While disaster payments are used here as an indicator of vulnerability, the federal programs that provide these payments (as well as other forms of crop insurance) are generally seen as a way to help farmers cope with risk and strengthen their adaptive capacity. Since many fruit and vegetable crops receive no federal subsidies, disaster payments and crop insurance are among the few remaining options for specialty crop producers (Richards 2000). However, as agricultural support programs receive greater scrutiny under tightening state and federal budgets, studies that examine the impact of potential reforms and their effects on vulnerability are needed. In contrast to government programs, the advantage of diversification to new crops, products, markets, or income sources is that farmers have more control over the outcome. But while diversification can help spread risk and facilitate a shift toward new crops should the need arise, concerted efforts to improve knowledge-sharing among stakeholders will be needed to overcome the risks and tradeoffs associated with unfamiliar cropping systems and market opportunities (Smit and Skinner 2002; O'Farrell and Anderson 2010).

2.3.5 Total Agricultural Vulnerability Index

Figure 2.6 provides an illustration of total agricultural vulnerability statewide by integrating the four sub-indices into one total AVI index. Based on this analysis, moderate vulnerability exists in most of California's agricultural lands, which suggests that there is a need for all agricultural communities to begin to develop adaptation plans that address the potential impact of changing climate, land use and economic factors. Many local and regional governments are now developing climate action plans that accompany updates to their general plans (Wheeler 2008; Haden et al., ms. submitted). To date, these climate action plans have mostly focused on greenhouse gas mitigation, but the results presented here suggest that adaptation should hold an equally important place in local planning activities.

The total AVI also suggests that there are several regions of concern that merit careful consideration. These include the Sacramento-San Joaquin Delta, the Salinas Valley, the corridor between Merced and Fresno, and the Imperial Valley, which all had a mix of high and very vulnerability. While the sub-indices discussed above help to highlight the location-specific factors contributing to these regions' overall vulnerability, the indexing method used in this study is inherently coarse. Given this limitation, future studies that follow a "place-based" approach will be needed in order to understand the unique local characteristics, both biophysical and socioeconomic, that may contribute to improved resilience within agricultural communities. The recently completed case study of agricultural adaptation to climate change in Yolo County, summarized in Section 3 below, is an early example of how to integrate these elements (Jackson et al. 2012).

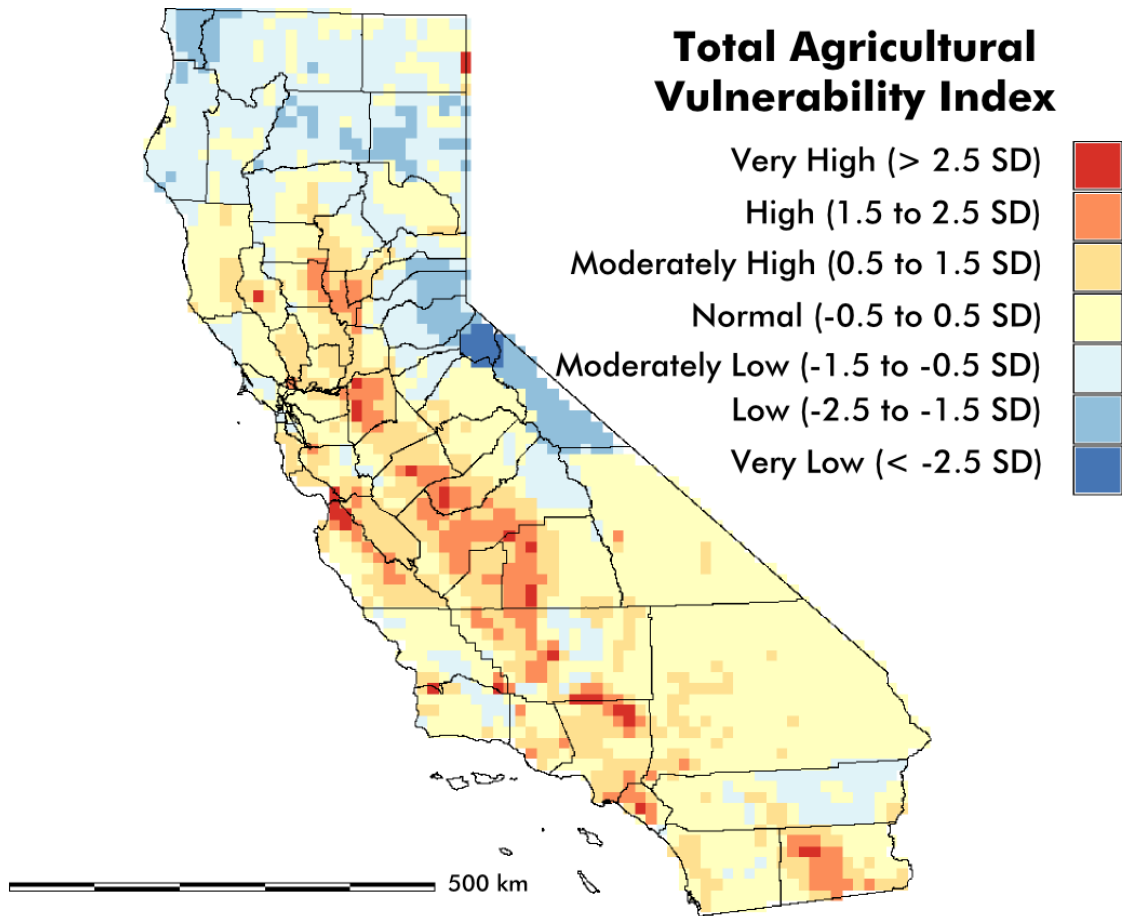

Figure 2.6. Total Agricultural Vulnerability Index (AVI) Which Integrates the Four Sub-Indices for Climate Vulnerability, Crop Vulnerability, Land Use Vulnerability, and Socioeconomic Vulnerability. Vulnerability level is assigned based on standard deviation (SD).

2.4. Future Directions for the California Agricultural Vulnerability Index

While the AVI presented above represents an early a proof of concept, significant gaps remain in the set of potential variables that could be included in the index. In particular, future iterations of the AVI will need to consider additional variables that more fully assess the vulnerabilities to California’s water resources and livestock systems in a spatially explicit manner. For livestock, studies that evaluate statewide spatial variation in the season length of adequate forage and its links with winter precipitation may be a useful addition (George et al. 2001; Chaplin-Kramer et al. 2012). These are but a few of the many types of spatial datasets that might be integrated in to the California AVI.

In its current form, the AVI is designed to assess “present” agricultural vulnerability. However, going forward there is potential to modify the AVI so that it can accommodate future projections of climate, land use, and socioeconomic variables. For example, integrating downscaled climate projections into the climate vulnerability sub-index, or integrating

statewide UPlan runs into the land use vulnerability sub-index, are very feasible next steps (Cayan et al. 2008; Thorne et al., in prep.). Yet, since many of the biophysical and socioeconomic factors included in the sub-indices can vary unpredictably over time, and in some cases have not been accurately modeled into future, use of the AVI to examine future scenarios may have inherent limitations. To overcome the potential limits, contributions of expertise and data from a broad range of stakeholders, government agencies, and academic disciplines will no doubt be required.

2.5 References

- Adger, W. N., N. Brooks, G. Bentham, M. Agnew, and S. Eriksen. 2004. *New indicators of vulnerability and adaptive capacity*. Norwich, UK: Tyndall Centre for Climate Change Research.
- Adger, W. N. 2006. "Vulnerability." *Global Environmental Change* 16: 268–281.
- Adger, W. N., S. Agrawala, M. M. Q. Mirza, C. Conde, K. O'Brien, J. Pulhin, R. Pulwarty, B. Smit, and K. Takahashi. 2007. Assessment of adaptation practices, options, constraints and capacity. *Climate Change 2007: Impacts, Adaptation and Vulnerability. Contribution of Working Group II to the Fourth Assessment Report of the Intergovernmental Panel on Climate Change*, M. L. Parry, O. F. Canziani, J. P. Palutikof, P. J. van der Linden, and C. E. Hanson, eds., Cambridge University Press: Cambridge, UK. 717–743.
- Backlund, V. L., and R. R. Hoppes. 1984. "Status of soil salinity in California." *California Agriculture*.
- Baldocchi, D., and S. Wong. 2008. "Accumulated winter chill is decreasing in the fruit growing regions of California." *Climatic Change* 87: 153–166.
- Bale, J. S., et al. 2002. "Herbivory in global climate change research: Direct effects of rising temperature on insect herbivores." *Global Change Biology* 8(1): 1–16.
- Brekke, L., M. Dettinger, E. Maurer, and M. Anderson. 2008. "Significance of model credibility in estimating climate projection distributions for regional hydroclimatological risk assessments." *Climatic Change* 89(3): 371–394.
- Brooks, N., W. N. Adger, and P. M. Kelly. 2005. The determinants of vulnerability and adaptive capacity at the national level and the implications for adaptation. *Global Environmental Change* 15: 151–163.
- Bryan, E., T. T. Deressa, G. A. Gbetibouo, and C. Ringler. 2009. "Adaptation to climate change in Ethiopia and South Africa: Options and constraints." *Environmental Science and Policy* 12(4): 413–426.
- Burton, C., and S. L. Cutter. 2008. "Levee failures and social vulnerability in the Sacramento-San Joaquin delta area, California." *Natural Hazards Review* 9(3): 136–149.

- California Roundtable on Water and Food Supply. 2011. Agricultural water stewardship: Recommendations to optimize outcomes for specialty crop growers and the public in California.
[http://aginnovations.org/images/uploads/CRWFS Water Stewardship Recs electronic.pdf](http://aginnovations.org/images/uploads/CRWFS_Water_Stewardship_Recs_electronic.pdf).
- CEDD (California Employment Development Department). 2010. Available online at:
<http://www.labormarketinfo.edd.ca.gov>.
- Cayan, D. R., E. P. Maurer, M. D. Dettinger, M. Tyree, and K. Hayhoe. 2008. "Climate change scenarios for the California region." *Climatic Change* 87(1): S21–S42 (99).
- Chaplin-Kramer, R., et al. 2012. *Climate Change and the Agricultural Sector in the San Francisco Bay Area: Changes in Viticulture and Rangeland Forage Production Due to Altered Temperature and Precipitation Patterns*. California Energy Commission. Publication number: CEC-500-2012-033.
- Cutter, S. L., B. J. Boruff, and W. L. Shirley. 2003. "Social vulnerability to environmental hazards." *Social Science Quarterly* 84(2).
- Cutter, S. L., and C. Finch. 2008. "Temporal and spatial changes in social vulnerability to natural hazards." *Proceedings of the National Academy of Sciences* 105(7): 2301–2306. SOVI data available online at: <http://webra.cas.sc.edu/hvri/products/sovi.aspx>.
- Cutter, S. L., C. T. Emrich, J. J. Webb, and D. Morath. 2009. Social vulnerability to climate variability hazards: A review of the literature. Hazards and Vulnerability Research Institute. Available at: http://adapt.oxfamamerica.org/resources/Literature_Review.pdf.
- Delworth, T. L., A. J. Broccoli, A. Rosati, R. J. Stouffer, V. Balaji, J. A. Beesley, W. F. Cooke, K. W. Dixon, J. Dunne, K. A. Dunne, J. W. Durachta, K. L. Findell, P. Ginoux, A. Gnanadesikan, C. T. Gordon, S. M. Griffies, R. Gudgel, M. J. Harrison, I. M. Held, R. S. Hemler, L. W. Horowitz, S. A. Klein, T. R. Knutson, P. J. Kushner, A. R. Langenhorst, H. Lee, S. Lin, J. Lu, S. L. Malyshev, P. C. D. Milly, V. Ramaswamy, J. Russell, M. D. Schwarzkopf, E. Shevliakova, J. J. Sirutis, M. J. Spelman, W. F. Stern, M. Winton, A. T. Wittenberg, B. Wyman, F. Zeng, and R. Zhang. 2006. GFDL's CM2 Global Coupled Climate Models. Part I: Formulation and Simulation Characteristics. American Meteorological Society.
- Dow, K., R. E. O'Connor, B. Yarnal, G. J. Carbone, and C. L. Jocoy. 2007. "Why worry? Community water system managers' perceptions of climate vulnerability." *Global Environmental Change* 17(2): 228–237.
- Eakin, H., and A. L. Luers. 2006. "Assessing the vulnerability of social-environmental systems." *Annual Review of Environment and Resources* 31: 365–394.
- EWG. 2011. Environmental Working Group 2011 Farm Subsidy Database. Available online at:
http://farm.ewg.org/progdetail.php?fips=06000&progcode=total_dis&page=county®ionname=California.

- Federal Emergency Management Agency (FEMA) Map Service Center. 2008. Q3 digital flood data.
- Fry, J. A., M. J. Coan, C. G. Homer, D. K. Meyer, and J. D. Wickham. 2009. *Completion of the National Land Cover Database (NLCD) 1992–2001 Land cover change retrofit product*. U.S. Geological Survey Open-File Report 2008(1379). 18.
- George, M., J. Bartolome, N. McDougald, M. Connor, C. Vaughn, and G. Markegard. 2001. Annual range forage production, University of California Division of Agriculture and Natural Resources, Rangeland Management Series, Publication 8010. p 9.
- Gleick, P. H., et al. 2000. Water: Potential Consequences of Climate Variability and Change for the Water Resources of the United States. Report of the Water Sector Assessment Team of the National Assessment of the Potential Consequences of Climate Variability and Change. Oakland, California, USA. Pacific Institute for Studies on Development, Economics, and Security: 151.
- Gratten, S., C. Grieve, J. Poss, P. Robinson, D. Suarez, and S. Benes. 2002. Reuse of saline-sodic drainage water for irrigation in California: Evaluation of potential forages. Proceedings of the 17th WCSS Conference, August 14–21st, Thailand Symposium 33, Paper 110. p. 10.
- Haden, V. R., M. Dempsey, S. Wheeler, W. Salas, and L. E. Jackson. Involving local agriculture in California's climate change policy: An inventory of agricultural greenhouse gas emissions in Yolo County. Manuscript submitted.
- Hanson, B. R., and D. M. May. 2004. "Effect of subsurface drip irrigation on processing tomato yield, water table depth, soil salinity and profitability." *Agricultural Water Management* 68: 1–17.
- Hanson, B. R., J. W. Hopmans, and J. Simunek. 2008. "Leaching with subsurface drip irrigation under saline shallow groundwater conditions." *Vadose Zone Journal* 7(2): 1–9.
- Hatfield, J., K. Boote, P. Fay, L. Hahn, C. Izaurralde, B. A. Kimball, T. Mader, J. Morgan, D. Ort, W. Polley, A. Thomson, and D. Wolfe. 2008. Agriculture. In: *The effects of climate change on agriculture, land resources, water resources, and biodiversity in the United States*. A report by the U.S. Climate Change Science Program and the Subcommittee on Global Change Research. Washington, D.C., USA. 362 pp.
- Heltberg, R., and M. Bonch-Osmolovskiy. Mapping Vulnerability to Climate Change. 2011. World Bank Policy Research Working Paper No. 5554. Available at SSRN: <http://ssrn.com/abstract=1754347>.
- Herfindahl, O. C. 1950. Concentration in the U.S. Steel Industry. Doctoral Dissertation, Columbia University.
- Hirschman, A. O. 1964. "The Paternity of an Index." *The American Economic Review* 54(5): 761.

- Hollander, A. D. 2007. California Augmented Multisource Landcover Map. Information Center for the Environment, University of California, Davis, California. Retrieved September 1, 2011 from <http://cain.ice.ucdavis.edu/caml>.
- Jackson, L. E., F. Santos-Martin, A. D. Hollander, W. R. Horwath, R. E. Howitt, J. B. Kramer, A. T. O'Geen, B. S. Orlove, J. W. Six, S. K. Sokolow, D. A. Sumner, T. P. Tomich, and S. M. Wheeler. 2009. *Potential for adaptation to climate change in an agricultural landscape in the central valley of California*. California Climate Change Center Report. Publication number: CEC-500-2009-044-F.
- Jackson, L. E., M. van Noordwijk, J. Bengtsson, W. Foster, L. Lipper, M. Pulleman, M. Said, J. Snaddon, and R. Vodouh. "Biodiversity and agricultural sustainability: From assessment to adaptive management." 2010. *Current Opinion in Environmental Sustainability* 2(1-2): 80–87.
- Jackson, L. E., S. M. Wheeler, A. D. Hollander, A. T. O'Geen, B. S. Orlove, J. W. Six, D. A. Sumner, F. Santos-Martin, J. B. Kramer, W. R. Horwath, R. E. Howitt, and T. P. Tomich. 2011. "Case study on potential agricultural responses to climate change in a California landscape." *Climatic Change* 109 (Suppl 1): S407–S427.
- Jackson, L. E., V. R. Haden, A. Hollander, H. Lee, M. Lubell, V. Mehta, T. O'Geen, M. Niles, J. Perlman, D. Purkey, W. Salas, D. Sumner, M. Tomuta, M. Dempsey, and S. Wheeler. 2012. *Adaptation Strategies for Agricultural Sustainability in Yolo County, California*. California Energy Commission. Publication number: CEC-500-2012-032.
- James, L. A., and S. L. Cutter. 2008. "Flood hazards in the Central Valley of California." *Natural Hazards Review* 9(3): 101–103.
- Joyce, B., V. Mehta, D. Purkey, L. Dale, and M. Hanemann. 2009. *Climate Change Impacts on Water Supply and Agricultural Water Management in California's Western San Joaquin Valley, and Potential Adaptation Strategies*. California Climate Change Center. Report no. CEC-500-2009-051-F.
- Kaiser, H. F. 1960. "The application of electronic computers to factor analysis." *Educational and Psychological Measurement* 20: 141–151.
- Kingwell, R. 2006. "Climate change in Australia: Agricultural impacts and adaptation." *Australasian Agribusiness Review* 14: 47119.
- Kiparsky, M., and P. H. Gleick. 2003. *Climate Change and California Water Resources: A Survey and Summary of the Literature*. California Climate Change Center. Report no. CEC-500-04-073.
- Knutson, T. R., T. L. Delworth, K. W. Dixon, I. M. Held, J. Lu, V. Ramaswamy, M. D. Schwarzkopf, G. Stenchikov, and R. J. Stouffer. 2006. "Assessment of Twentieth-Century Regional Surface Temperature Trends Using the GFDL CM2 Coupled Models." *Journal of Climate* 1624(19).

- Larson, A. 2000. Migrant and seasonal farmworker enumeration profiles study. California. Migrant Health Program Bureau of Primary Health Care. Health Resources and Services Administration.
- Leary, N., J. Adejuwon, W. Bailey, V. Barros, M. Caffera, S. Chinvano, C. Conde, A. De Comarmond, A. De Sherbinin, T. Downing, H. Eakin, A. Nyong, M. Opondo, B. Osman, R. Payet, F. Pulhin, J. Pulhin, J. Ratnasiri, E. Sanjak, G. von Maltitz, M. Wehbe, Y. Yin, and G. Ziervogel. 2006. For Whom the Bell Tolls: Vulnerabilities in a Changing Climate. AIACC Working Paper No. 30, International START Secretariat, Washington, District of Columbia. 31 pp.
- Leichenko, R., and K. O'Brien. 2002. "The Dynamics of Rural Vulnerability to Global Change." *Mitigation and Adaptation Strategies for Global Change* 7(1): 1–18.
- Lisansky, J. 1986. "Farming in an urbanizing environment: Agricultural land use conflicts and rights to farm." *Human Organization* 45(4): 363–371.
- Luedeling, E., M. Zhang, and E. H. Girvetz. 2009. "Climatic Changes Lead to Declining Winter Chill for Fruit and Nut Trees in California during 1950–2099." *PLoS ONE* 4(7): e6166.
- Maurer, E. P., H. G. Hidalgo, T. Das, M. D. Dettinger, and D. R. Cayan. 2010. "The utility of daily large-scale climate data in the assessment of climate change impacts on daily streamflow in California." *Hydrology and Earth System Sciences* 14(6): 1125–1138.
- NASS. 2002. California State Level Statistics. U.S. Department of Agriculture, National Agriculture Statistics Service, Washington D.C. Accessed May 2011. Available online at http://www.agcensus.usda.gov/Publications/2002/Volume_1_Chapter_1_State_Level/California/index.asp.
- NASS. 2007. California State Level Statistics. U.S. Department of Agriculture, National Agriculture Statistics Service, Washington, D.C. Accessed May 2011. Available online at http://www.agcensus.usda.gov/Publications/2007/Full_Report/Volume_1_Chapter_1_State_Level/California/index.asp.
- O'Brien, K. L., and R. M. Leichencko. 2000. "Double exposure: Assessing the impacts of climate change within the context of economic globalization." *Global Environmental Change* 10: 221–232.
- O'Brien, K., R. Leichencko, U. Kelkar, H. Venema, G. Aandahl, et al. 2004. "Mapping vulnerability to multiple stressors: Climate change and globalization in India." *Global Environmental Change* 14:303–313.
- O'Connor, R. E., R. Bord, K. Dow, and B. Yarnal. 2001. Risk perceptions of natural hazards: community water system managers in Pennsylvania and South Carolina. In: Y. Y. Haimes, D. A. Moser, and E. Z. Stakhiv, editors. *Risk-Based Decision Making in Water Resources IX*. American Society of Civil Engineers, Reston, Virginia. 87–95.

- O'Farrell, P. J., and P. M. L. Anderson. 2010. "Sustainable multifunctional landscapes: A review to implementation." *Current Opinion in Environmental Sustainability* 2(1-2), 59–65.
- Porter, M. E. 1998. "Clusters and the new economics of competition." *Harvard Business Review* 76(6): 77–90.
- Purkey, D. R., B. Joyce, S. Vicuna, M. W. Hanemann, L. L. Dale, D. Yates, and J. A. Dracup. 2008. "Robust analysis of future climate change impacts on water for agriculture and other sectors: A case study in the Sacramento Valley." *Climatic Change* 87: 109–122.
- Richards, T. J. 2000. "A two-stage model of the demand for specialty crop insurance." *Journal of Agricultural and Resource Economics* 25(1): 177–194.
- Simpson, E. H. 1949. "Measurement of diversity." *Nature* 163: 688.
- Smit, B., and M. W. Skinner. 2002. "Adaptation options in agriculture to climate change: A typology." *Mitigation and Adaptation Strategies for Global Change* 7: 85–114.
- Smit, B., and J. Wandel. 2006. "Adaptation, adaptive capacity and vulnerability." *Global Environmental Change* 16: 282–292.
- Sokolow, A. D., S. V. Hammond, M. Norton, and E. E. Schmidt. 2010. "California communities deal with conflict and adjustment at the urban-agricultural edge." *California Agriculture* 64(3): 121–128.
- Storie, R. E. 1978. Storie Index Soil Rating. Division of Agricultural Sciences. University of California. Special publication 3203.
- Tanaka, S. K., T. Zhu, J. R. Lund, R. E. Howitt, M. W. Jenkins, M. A. Pulido, M. Tauber, R. S. Ritzema, and I. C. Ferreira. 2006. "Climate Warming and Water Management Adaptation for California." *Climatic Change* 76: 361–387.
- Thorne, J., J. Bjorkman, and N. Roth. 2012. Urban Growth in California: Projecting Growth in California (2000–2050) Under Six Alternative Policy Scenarios and Assessing Impacts to Future Dispersal Corridors, Fire Threats and Climate-Sensitive Agriculture. California Energy Commission. Publication number: CEC-500-2012-009.
- Wheeler, S. 2008. "State and municipal climate change plans." *Journal of the American Planning Association* 74(4): 481–495.
- Yao, H., and A. Georgakakos. 2001. "Assessment of Folsom Lake response to historical and potential future climate scenarios; 2. reservoir management." *Journal of Hydrology* 249(1–4): 176–19.

3.0 Agricultural Mitigation and Adaptation to Climate Change in Yolo County, California

L. E. Jackson, V. R. Haden, A. Hollander, H. Lee, M. Lubell, V. Mehta, A. T. O'Geen, M. Niles, J. Perlman, D. Purkey, W. Salas, D. A. Sumner, M. Tomuta, M. Dempsey, and S. M. Wheeler

3.1 Introduction to the Place-based Agriculture Adaptation Study

Few place-based studies have been conducted at the landscape scale to address climate change and agricultural sustainability (i.e., achieving agricultural productivity and profitability, environmental quality, and social well-being). A place-based vulnerability approach considers climate change to be one of several interrelated issues such as changes in commodity production, stewardship of natural resources, land use, population growth, and urbanization in a regional system. Awareness of vulnerability issues can activate adaptive responses, as long as communities have the collective ability to assemble and process information, and use it to respond in site-specific and context-relevant ways (Adger 2003).

Yolo County, in California's Central Valley, is the focus of a place-based case study where an interdisciplinary group of researchers has worked with several types of stakeholders to understand potential vulnerabilities to climate change and options for adaptive management. Phase I of the study relied on literature review of management and GHG emissions for various crops, historical records of resource use, and geographic information system (GIS)-based queries of land use, to understand the capacity and constraints for both mitigation and adaptation to climate change (Jackson et al. 2011). This new phase (Phase II) takes a more quantitative approach to understanding adaptation options, and several of the projects utilize General Circulation Model (GCM) data for future climate projections (Tyree and Cayan, unpublished data). Phase II is summarized here as an overview of the main findings; some of the text is directly excerpted from the much longer companion paper to the California Energy Commission (Jackson et al. 2012). The sub-projects include the following:

- Econometric analysis of crop acreages under future climate change projections
- Use of the Water Evaluation and Planning (WEAP) model (Yates et al. 2005a, 2005b) to assess how future climatic and economic projections will affect the local water supply and to test the efficacy of various mitigation and water conservation strategies
- Survey of farmers' ideas and attitudes on climate change, and on climate change mitigation and adaptation strategies
- Assessment of countywide agricultural GHG emissions and engagement in the development of Yolo County's Climate Action Plan
- Exploration of how future urbanization scenarios might affect the county's farmland using the urban growth (UPlan) model

3.1.1 Yolo County: Background on Agriculture as Relevant to Climate Change

Preservation of agricultural land is a priority in Yolo County, and planning is focused on regional land use guidelines that maintain land in agricultural production and concentrate new development into urban areas. Regions within Yolo County are distinguished by their land forms (plains, hills, or mountains), proximity to the Sacramento River and Delta (and its cooler microclimate), water availability (surface water, groundwater, and the feasibility of irrigation deliveries), and the influence of small towns and cities (Figure 3.1). There is greater prevalence of wine grapes along the river, processing tomatoes in the alluvial plains, and organic fruits and vegetables in an isolated, narrow valley to the north. Flooding along the Sacramento River poses the most significant regional hazard from climate change; water flows will increase by at least 25 percent by 2050 due to a decrease in snowpack in the Sierra Nevada (Cayan et al. 2008).

As for most of California during the past few decades, there has been a trajectory toward less crop diversity, larger farm sizes, but fairly stable markets for commodities (Jackson et al. 2009; Jackson et al. in press). Most commodities are managed with high intensification of agricultural inputs (e.g., fossil fuels, fertilizers, and pesticides). The number of organic farms, however, is growing. A recent survey showed that many riparian corridors have low scores for soil quality and riparian health (Young-Mathews et al. 2010), and there is concern about transport of pesticides to the San Francisco Bay delta (Moore et al. 2008). Environmental quality is now receiving more attention with active grower participation in programs from several agencies.

3.1.2 Previous Work on Climate Change Impacts on Yolo County Agriculture

Phase I of this case study examined possible effects of increased temperature and decreased precipitation on Yolo County crops (Jackson et al. 2009). The horticultural “warm-season” crops in the county will experience more stress than field crops, due to greater environmental sensitivity of their reproductive biology, water content, visual appearance, and flavor quality. New horticultural crops may include “hot-season” crops (e.g., melon) in summer, and “cool-season” crops (e.g., lettuce and broccoli) that prefer warmer winters. Expansion of citrus and of heat and drought-tolerant trees (e.g., olive) are likely partly because fewer winter chill hours will be difficult for some stone fruits and nuts (Baldocchi and Wong 2008). Forage production for livestock in upland grasslands may increase with warmer temperatures during the winter rainy season, but field experiments with elevated carbon dioxide (eCO₂) do not corroborate this expectation (Shaw et al. 2002). More nitrogen (N) limitation will likely occur under eCO₂ (Dukes et al. 2005), unless N-fixing legumes become more abundant. During the past 25 years, crop diversity has decreased across Yolo County (Jackson et al. 2009), but resilience to extreme events, such as heat waves, may be enhanced in the future by a more diverse crop mix that varies in stress tolerance.

Water supply has been considered the most uncertain aspect of climate change for farmers in Yolo County, who rely on groundwater for about 30 to 40 percent of their supply in a normal water year (WRA 2005). Pests and diseases are another uncertainty for which little published literature exists. Discussions with the Yolo County UC Cooperative Extension farm advisors indicate special concern for stripe rust on wheat (especially under wetter conditions), insect

pests on nuts, medfly, corn earworm on tomato, tomato spotted wilt virus, stem nematode on alfalfa, and earlier activity of perennial weeds such as bindweed (Long 2010; Jackson et al. 2009).

Crop management is subject to change to improve production and environmental quality. Phase I evaluated a set of practices and found that most practices either benefitted GHG mitigation or benefitted adaptation to a changing climate. More comprehensive analysis of these complex relationships is needed. Phase I also considered agricultural adaptation strategies that addressed regional issues such as hydrology, growers' attitudes toward climate change, and urbanization versus preservation of farmland. These topics are explored in more quantitative ways here.

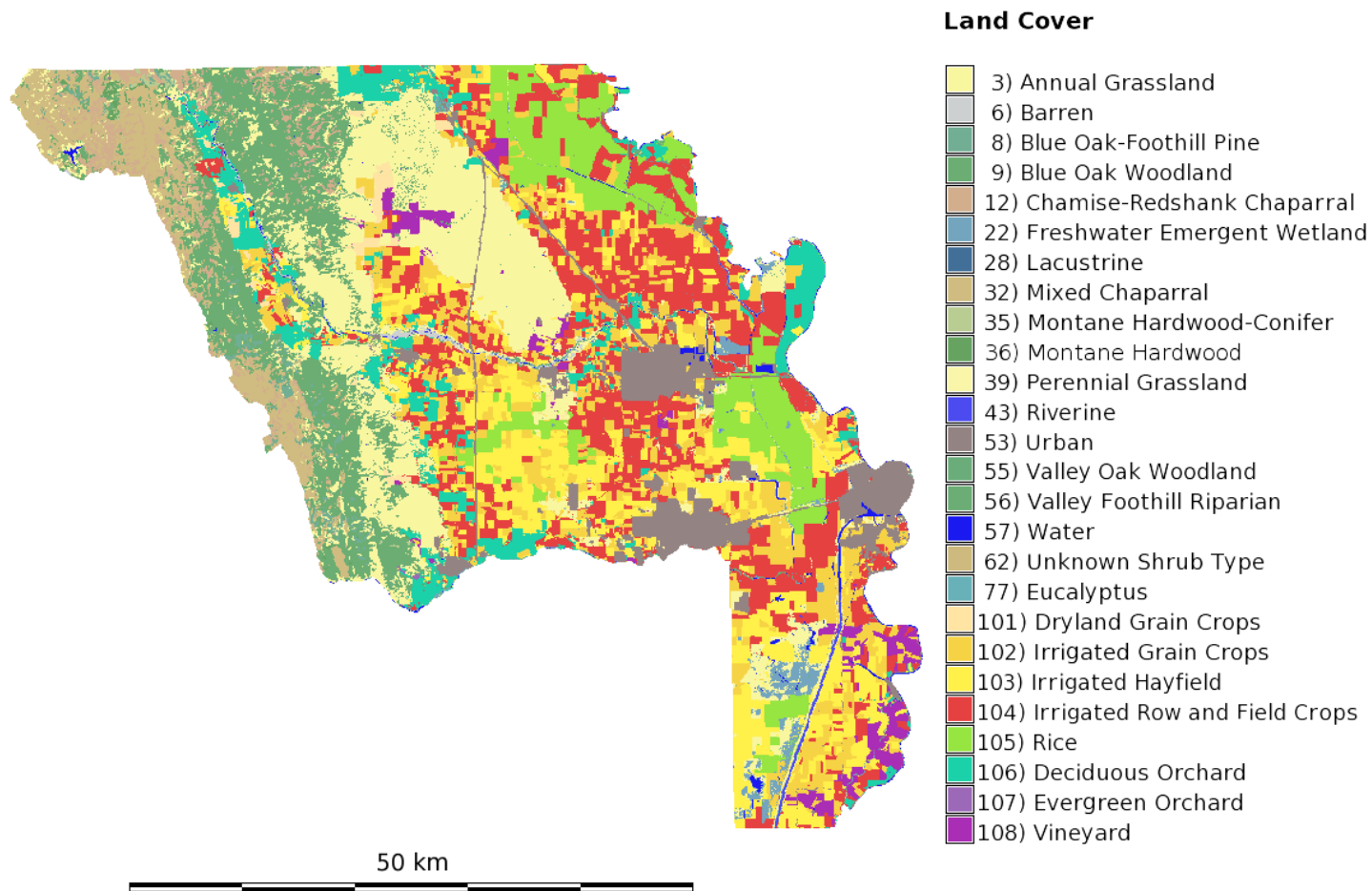

Figure 3.1. Map of Yolo County, California, Showing Land Use Types. The Sacramento River is the eastern boundary of the county. The Coast Range Mountains extend north-south along the western edge.

Source: DWR 1997

3.2 Climate-induced Changes in Acreage of Crops in Yolo County Including Projections to 2050

H. Lee and D. Sumner

Since 1960, total crop acreage in Yolo County has been declining. Vegetable and orchard crop areas have increased, while field crop acreage has declined (Figure 3.2). There has been an increase in higher-revenue-per-acre crops, especially a shift out of barley, and a shift into more processing tomatoes, wine grapes, and walnuts. Many factors affect changes in acreage, including changes in market conditions (relative prices), input supplies, and climate. Among factors affecting acreage decisions, we investigated whether changes in climate have affected acreage allocations across crops. If responses to climate changes in the past continue to hold in the future, we can use historical information to learn more about how crop acreages are likely to change in response to the forecasted Yolo County climate changes from 2010 to 2050.

We developed econometric models that relate acreages of each major crop to relative prices and key climate variables (see Jackson et al. 2012 for details and for data). The models are applied to the data including 60 years of acreage for major crops and 100 years of local climate history. Our climate history indicates that during the past century, the increase in annual temperature appears to be mainly due to warmer winters rather than to warmer summers (Figure 3.3). There was a decrease of about 150 winter chill hours in the last 100 years.

Using historical relationships between climate and acreage allows investigation of how forecasted climate changes in Yolo County may affect Yolo acreage patterns. Acreage projections use climate projections for the B1 (low greenhouse gas emissions) and A2 (high GHG emissions) scenarios from 2010 to 2050 with GCM data from GFDL-BCCA. Acreage projections hold constant relevant drivers of crop acreage, except for local climate variables.

Among field crops, warmer winter temperatures (2035–2050) were projected to cause wheat acreage to decline (Figure 3.4) and alfalfa acreage to rise (data not shown). Thus, future decisions to increase alfalfa acreage present an interesting implication for water use: wheat uses little irrigation; whereas, alfalfa is one of the more intense water users. By 2050, tomato acreage is projected to increase compared to the current level (data not shown). This is also related to the increase in growing degree days in the winter months. A warmer climate in late winter/early spring has allowed early planting and provided favorable conditions for establishment.

Historic Crop Acreage (1,000 acres) by Crop Category

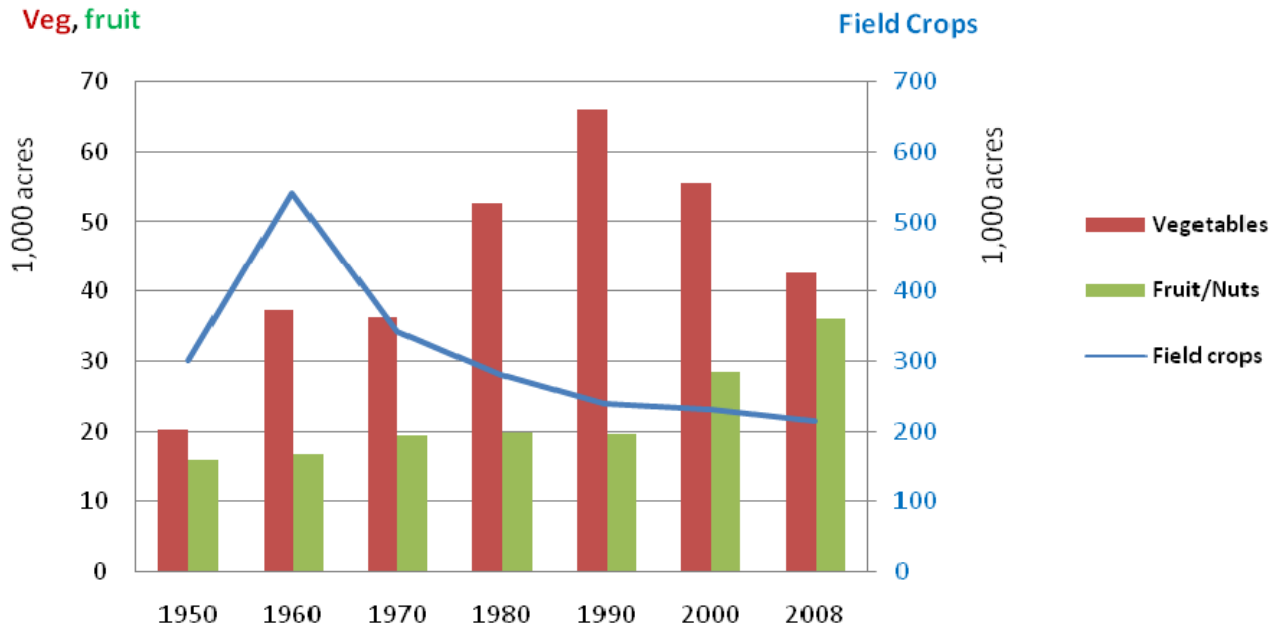

Figure 3.2. Historical Crop Acreage by Crop Category for Selected Years during 1950–2008

Source: Yolo County Agricultural Crop Report (1950–2008)

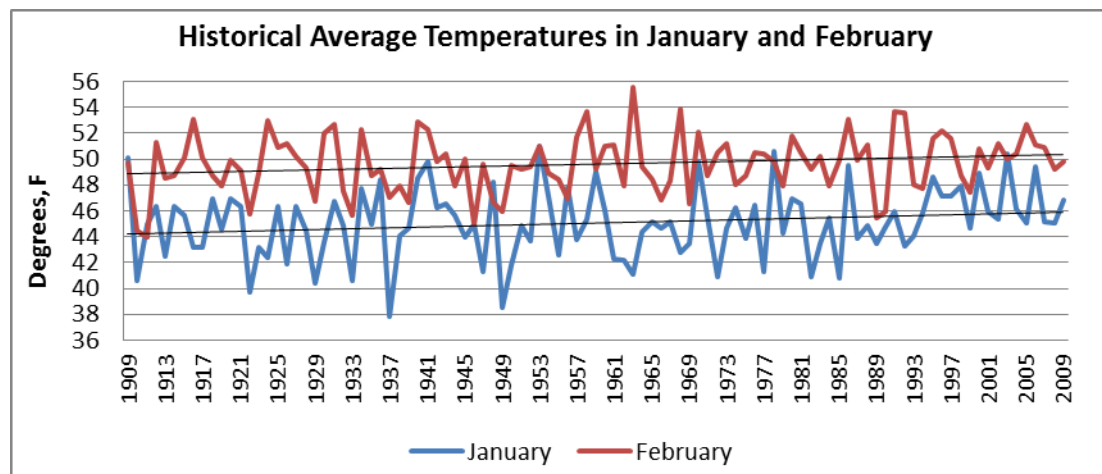
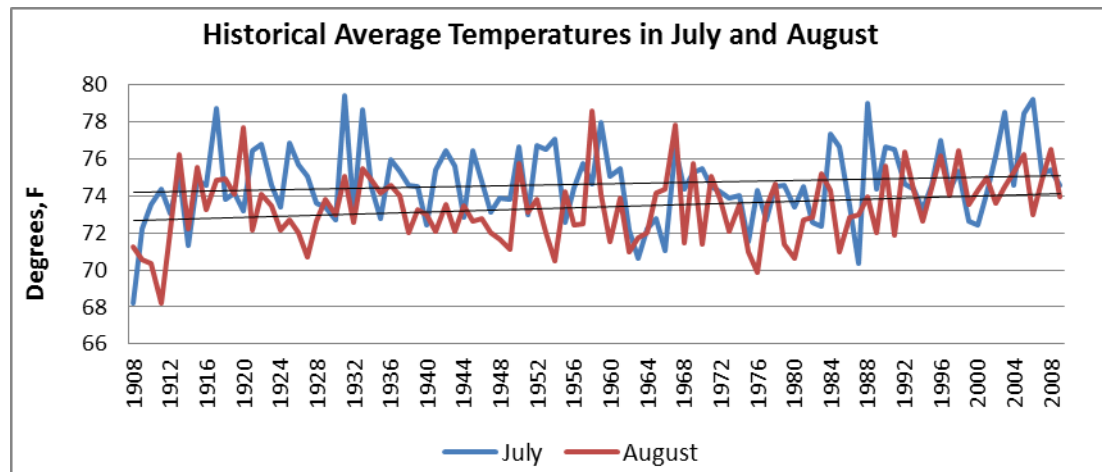

Figure 3.3. Historical Average Monthly Temperature (°f) for January and February Computed Using Daily Minimum and Maximum Temperatures for the Period of 1909–2008 for Davis, California

Source: NCDC/NOAA

The forecasted climate changes have only moderate impacts on projected tree and vine crop acreage, in part because the climate changes that have occurred have not yet affected key variables (such as chill hours or summer warmth) enough to induce a significant change in the acreage of perennials when market conditions have been favorable. Almond acreage is projected to increase slightly with warmer temperatures in 2035–2050 (data not shown). Almonds have a relatively low winter chill hour requirement. Walnut acreage, however, would decline slightly (data not shown); it has a higher winter chill requirement. This is consistent with the finding that surveyed orchard growers express concern about a decrease in winter chill hours (see Section 3.4).

These projections rely on using historical relationships between acreage change and climate variables change. They are based actual past responses of acreage to climate. However, no attempt is made to forecast the relative prices, technical changes, new markets, or other factors that will also affect acreage.

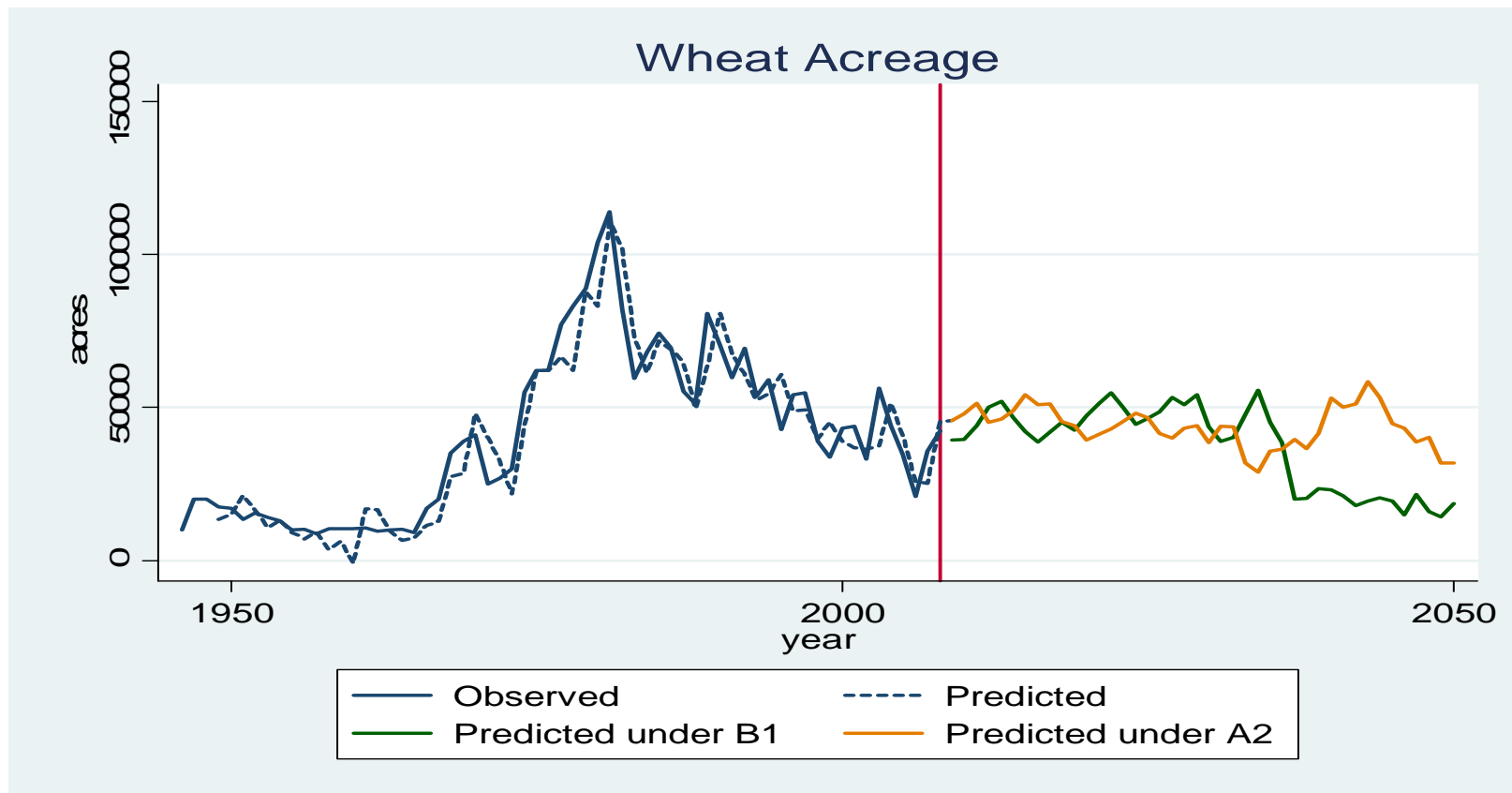

Figure 3.4. Wheat Acreage in Yolo County, in the Past and as Projected with an Econometric Model. The first half of the graph presents actual and projected acreage values in solid and dotted lines, respectively, and the second half presents projected acreage for the B1 and A2 scenarios for 2010–2050 using GFDL climate data. Crop acreages for 2008 were the starting point for the future modeling, and all other factors except climate were held constant until 2050.

3.3 Simulating the Effects of Climate Change and Adaptive Water Management on the Cache Creek Watershed: Alternative Agricultural Scenarios for a Local Irrigation District

V. K. Mehta, V. R. Haden, D. Purkey, J. Perlman, and L. E. Jackson

Water supply vulnerabilities for agriculture and other sectors can be mediated through traditional infrastructure improvements or alternative water policies (Medellín-Azuara et al. 2008). Local stewardship that is implemented by water managers and agricultural users tends to be more economical and have less environmental impact than developing new supplies. One tool that has helped water resource managers integrate climate change projections into their decision making process is the Water Evaluation and Planning (WEAP) system (Yates et al. 2005a; Yates et al. 2005b; Purkey et al. 2007). WEAP, a modeling platform that enables integrated assessment of a watershed's climate, hydrology, land use, infrastructure, and water management priorities (Joyce 2009; Purkey et al. 2008), is used here for the Yolo County Flood Control and Water Conservation District service area. It covers 41 percent of the county's irrigated area and is located in the western and central portion of the county (Figure 3.5).

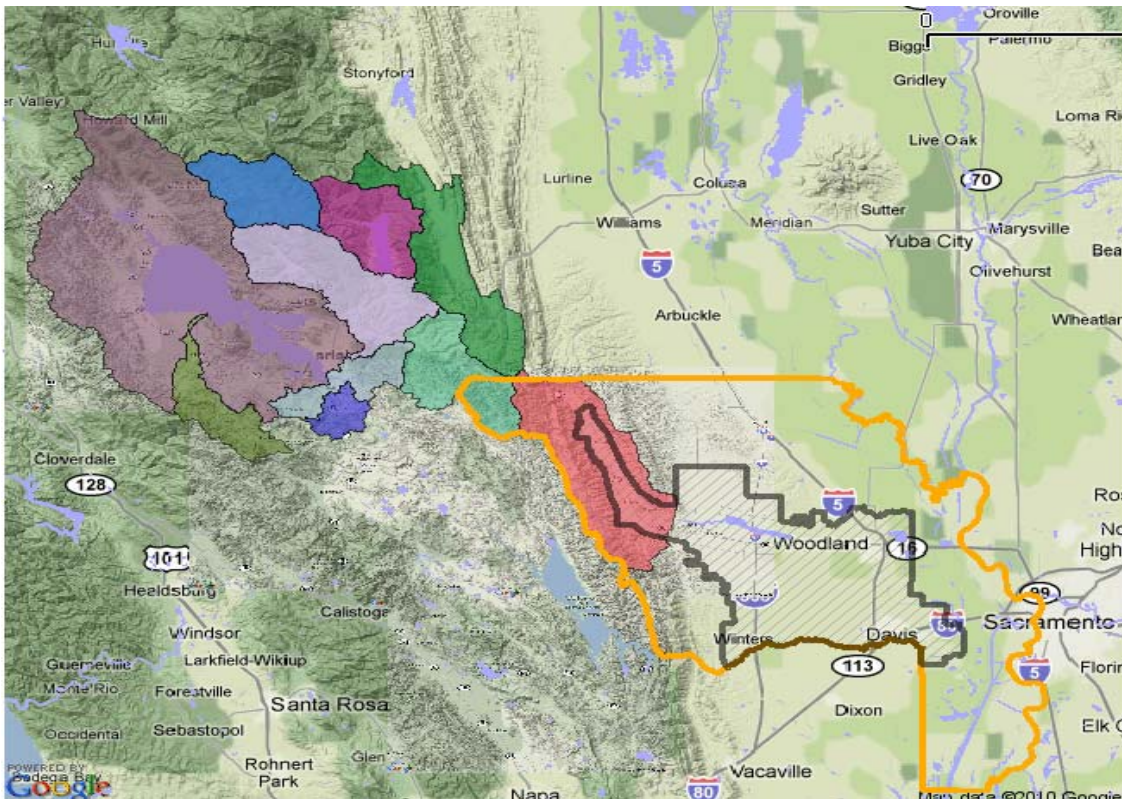

Figure 3.5. Map of the Study Area Modeled Using WEAP. Colored polygons are independently characterized catchments. Hatched polygon is the Yolo County Flood Control and Water Conservation District.

WEAP was set up to capture the explicit operating rules and legal decrees (e.g., Solano Decree for Clear Lake) which govern local water management decisions. This and another reservoir located upstream in neighboring Lake County are essential for deliveries and recovery of groundwater levels in Yolo County in recent decades. The Cache Creek model, run at a monthly time step, uses climate and land cover information to simulate water balance. On the demand side, the model simulates irrigation demand for 20 crop types within Yolo County, which is met through surface (higher priority) and groundwater sources (lower priority). Calibrated irrigation schedules and thresholds were produced for each crop. A simulation approach was used instead of hard-coding the demand based on the District's historical roster. The model was calibrated to a historical run from 1971–2000, which formed the baseline scenario. The calibrated model was then run under various combinations of climate and agricultural land use (i.e., crop proportions) with downscaled climate projections (GFDL-BCCA) from two Intergovernmental Panel on Climate Change (IPCC) emissions scenarios (A2 and B1) to simulate the District's future water supply and projected demand under a climate-only baseline and three hypothetical adaptation scenarios (Figure 3.6):

1. **Climate only:** The potential impacts of climate change alone, under the two IPCC emission scenarios (GFDL B1 and A2). Land use is held constant at the 2008 pattern. *What is the likely impact of climate change only?*
2. **Adaptation 1 (Climate and dynamic cropping):** These correspond to the econometric model that simulates future cropping patterns based on the B1 and A2 climate sequences. *What is the combined impact of climate change and a cropping pattern adaptation driven by forces similar to those in the past?*
3. **Adaptation 2 (Climate and crop diversification):** These correspond to a run of the hypothetical diversified cropping pattern, under the two Climate-only scenario runs. *What is the adaptive potential of a diversified cropping pattern dominated by increasing proportions of low-water consuming crops?*
4. **Adaptation 3 (Climate, crop diversification, and technology):** This corresponds to a run of the diversified land used projection from Adaptation 2 and the irrigation technology projections described in the paragraphs above. *What is the combined adaptive potential of a diversified cropping pattern (as in 3) plus water-conserving irrigation technology improvements?*

Overall, climate-driven impacts on surface water supplies, irrigation demand, and groundwater pumping are expected to be substantial under a projected warmer and drier climate, especially in A2 late in the century. The District is likely to face more frequent years with water deliveries either below full allocation and/or no-allocation) unless cropping systems change markedly. The collaboration with the District has generated awareness and a tool set for planning local conjunctive use policies to attempt to balance the benefits and tradeoffs of changing land use, irrigation technology, and irrigation sources.

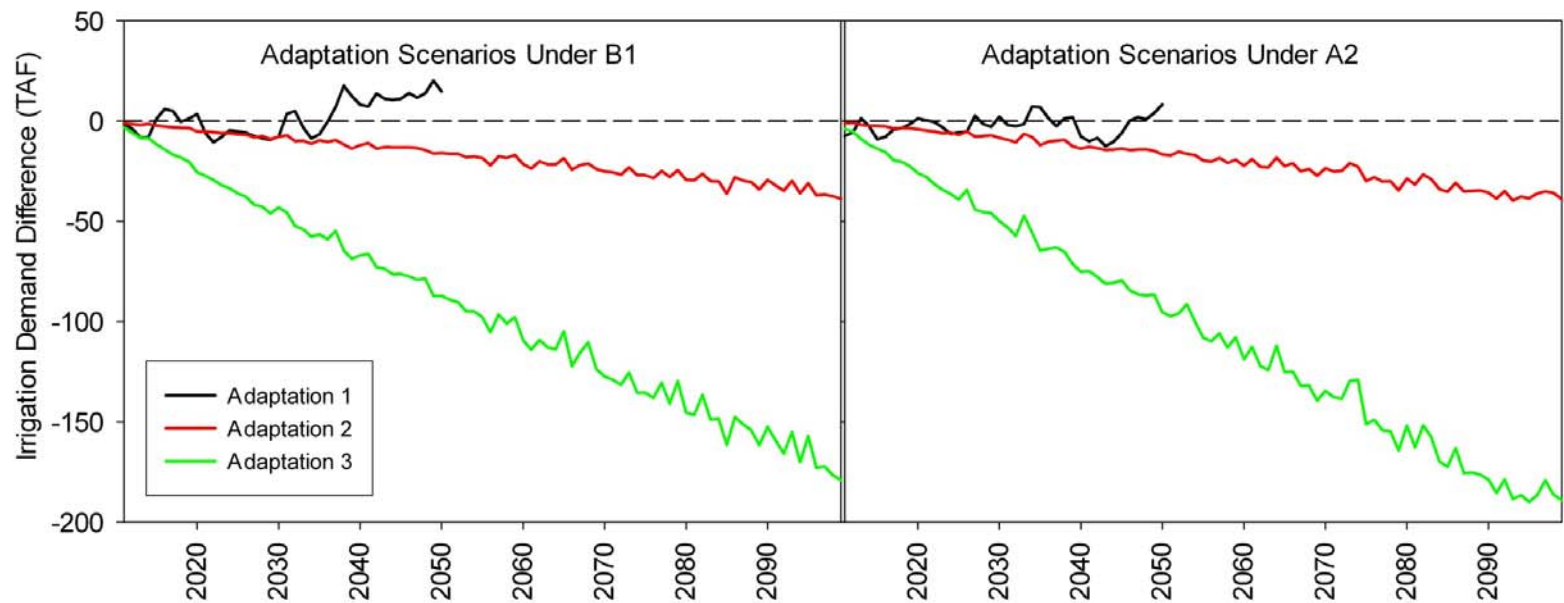

Figure 3.6. Difference in Projected Irrigation Demand for Three Adaptation Scenarios Relative to the Impact of Climate Alone (2009–2099). The B1 and A2 climate scenarios are derived from downscaled projections of the GFDL general circulation model. Adaptation 1 is based on land use projections derived from an econometric model for the 2009–2050 period. Adaptation 2 uses hypothetical land use projections, which assume a more diverse and water efficient cropping pattern. Adaptation 3 combines the diversified cropping pattern with a projected increase in irrigation technology adoption.

3.4 Involving Local Agriculture in California’s Climate Change Policy: An Inventory of Agricultural Greenhouse Gas Emissions in Yolo County

V. R. Haden, M. Dempsey, S. Wheeler, W. Salas, and L. E. Jackson

Recognizing the key role that land-use planning will play in achieving the goals of AB 32, legislators passed Senate Bill 375 (SB 375) in 2008, requiring sustainable land-use plans that are aligned with AB 32 (Hettinger 2011). Local governments must address GHG mitigation in the environmental impact report that accompanies any update to their general plan or carry out a specific “climate action plan” (CAGO 2009).

Emissions of GHG from agriculture are often missing from existing inventory tools geared to local planners. The local government of Yolo County was among the first in California to pass a climate action plan (Yolo County 2010). This project contributed to this climate action plan, and developed a set of guidelines to estimate GHG emissions from agriculture within a local inventory framework (Haden et al., ms. submitted). The Tier 1 methods used here have been adapted for local activity data largely from three main sources: (1) the California Air Resources Board Technical Support Document for the 1990–2004 California GHG Emissions Inventory (ARB 2009); (2) the U.S. Environmental Protection Agency (U.S. EPA) Emissions Inventory Improvement Program Guidelines (U.S. EPA 2004, 2010); and (3) the 2006 IPCC Guidelines for National GHG Inventories (IPCC 2006).

In Yolo County, total agricultural emissions declined by 10.4 percent between 1990 and 2008 (Table 3.1). The main reason was a reduction in direct and indirect nitrous oxide (N₂O) emissions. Lower fertilizer use was driven by two important land use trends: (1) a 6 percent reduction in the county’s irrigated cropland; and (2) a general shift away from crops that have high N rates (e.g., corn, tomatoes) coupled with an expansion in alfalfa and grape area, which require less fertilizer (Table 3.2).

In both years, emissions of CO₂, N₂O, and methane (CH₄) from diesel-powered mobile farm equipment were responsible for 20.0 to 23.0 percent of total agricultural emissions in Yolo County between 1990 and 2008 (Table 3.2). Fuel consumption per unit area for several important crops (e.g., rice, corn, tomatoes, melons, and miscellaneous vegetables) offset the small decline in irrigated cropland.

Using the Tier 1 method prescribed by ARB, emissions of CH₄ from rice cultivation were estimated to increase from 25.9 to 31.2 kilotons (kt) carbon dioxide equivalent (CO₂e) between 1990 and 2008, entirely due to an expansion in the area under rice cultivation. Studies also suggest that cultivation practices that combine straw incorporation and winter flooding tend to generate more CH₄ emissions than burning rice straw (Fitzgerald et al. 2000). Thus, estimates generated using the DeNitrification-DeComposition (DNDC) model showed a larger increase in emissions over the study period (32.2 to 57.9 kt CO₂e) because the Tier 3 method accounted for changes in residue and water management made in compliance with the state air quality

regulations that have phased out rice straw burning, and the increase in cultivated area (data not shown).

Many agricultural practices to mitigate GHG emissions offer agricultural co-benefits. For example, economic factors are prompting local farmers to shift more of their land to crops that happen to require less N fertilizer and diesel fuel, and to adopt practices that reduce these inputs. Growers cite rising cost and market volatility of inputs, rather than mitigation *per se*, as a more immediate motivation to use fertilizer and fuel more efficiently.

In 1990, emissions sources associated with urban areas accounted for approximately 86 percent of the total GHG emissions countywide, while unincorporated areas supporting agriculture were responsible for 14 percent (Yolo County 2010). If calculated on an area-wide basis the county's urban areas emitted approximately 152.0 tons (t) CO_{2e} per hectare per year (ha⁻¹ yr⁻¹). By contrast, this inventory results indicates that in 1990 Yolo County's irrigated cropland averaged 2.16 t CO_{2e} ha⁻¹ yr⁻¹ and that livestock in rangelands emitted only 0.70 t CO_{2e} ha⁻¹ yr⁻¹ (data not shown). This 70-fold difference in the annual rate of emissions between urbanized land and irrigated cropland suggests that land-use policies that protect existing farmland from urban development are likely to help stabilize and or reduce future GHG emissions, particularly if they are coupled with "smart growth" policies that prioritize urban infill over expansion (see Section 3.6).

Table 3.1. Summary of Yolo County Agricultural CO₂, N₂O, and CH₄ emissions (kt CO₂e) for 1990 and 2008, by Source Category. Estimates were made using Tier 1 methods, activity data based on local agricultural practices, and default emission factors. For detailed methods see Jackson et al. (2012).

Source Category	1990 Emissions					2008 Emissions					Change since 1990
	CO ₂	N ₂ O	CH ₄	Total	Annual	CO ₂	N ₂ O	CH ₄	Total	Annual	
	----- kt CO ₂ e -----				%	----- kt CO ₂ e -----				%	
Direct N ₂ O from soil	---	126.55	---	126.55	37.0	---	97.27	---	97.27	31.8	- 23.1
Indirect N ₂ O	---	36.43	---	36.43	10.7	---	26.68	---	26.68	8.7	- 26.8
Mobile farm equipment	71.00	0.57	0.21	71.78	21.0	69.43	0.55	0.21	70.19	23.0	- 2.2
Irrigation pumping	39.16	0.31	0.12	39.59	11.7	40.54	0.32	0.12	40.98	13.5	3.5
Livestock ¹	---	<i>10.64</i>	26.53	26.53	7.8	---	<i>12.39</i>	31.84	31.84	10.5	20.0
Rice cultivation	---	---	25.92	25.92	7.7	---	---	31.16	31.16	10.2	20.2
Residue burning ²	---	4.86	1.76	6.61	2.0	---	1.59	0.83	2.42	0.8	- 63.4
Lime	4.35	---	---	4.35	1.3	2.32	---	---	2.32	0.8	- 46.7
Urea	4.15	---	---	4.15	1.2	3.46	---	---	3.46	1.1	- 16.7
Total	118.66	168.71	54.54	341.92		115.74	126.41	64.16	306.31		- 10.4

¹N₂O from N excreted by livestock (in italics) is assumed to be applied to soil as manure or urine, thus it is only included in the totals for direct and indirect N₂O.

²CO₂ emissions from residue burning (104.92 Kt in 1990 and 42.69 Kt in 2008) is considered a biogenic emission, thus was not included in the total.

Table 3.2. Cultivated Area, Production Input Rates and Estimated Emissions for Yolo County Crop Categories in 1990 and 2008. Estimated emissions for direct N₂O, indirect N₂O, and mobile farm equipment are based on Tier 1 inventory methods, local activity data, and default emission factors.

Crop Category	Production Input Rates ²								Estimated Emissions					
	Cultivated Area ¹		N Fertilizer		Crop Residue		Agricultural Fuel		Direct N ₂ O		Indirect N ₂ O		Mobile Farm Equipment	
	1990	2008	1990	2008	1990	2008	1990	2008	1990	2008	1990	2008	1990	2008
	----- ha -----		----- kg N ha ⁻¹ yr ⁻¹ -----				-- L ha ⁻¹ yr ⁻¹ --		----- kg CO _{2e} ha ⁻¹ yr ⁻¹ -----					
Alfalfa	14,569	22,950	12	12	57	68	85	33	338	389	20	20	228	88
Almond	3,054	4,639	224	247	---	---	269	103	1092	1201	355	390	727	278
Corn	6,070	3,285	392	269	99	112	137	262	2394	1857	621	426	369	706
Grain Hay	5,099	6,804	112	90	51	77	56	56	794	811	177	142	151	151
Grapes	640	4,857	56	45	---	---	215	215	273	218	89	71	580	580
Irrigated Pasture	5,261	5,261	50	50	---	---	2	2	246	246	80	80	6	6
Melons	2,145	578	146	196	---	---	306	1169	710	955	231	310	826	3154
Prunes	880	851	168	168	---	---	168	168	819	819	266	266	454	454
Rice	10,117	12,164	191	207	12	48	186	253	337	535	302	328	502	681
Safflower	11,214	5,469	112	112	---	---	122	122	546	546	177	177	328	328
Tomato	24,079	15,204	224	235	---	---	514	730	1092	1146	355	373	1387	1968
Walnuts	2,739	3,606	224	224	---	---	106	56	1092	1092	355	355	287	151
Wheat	28,428	17,158	224	135	68	73	115	123	1424	1008	355	213	311	333
Misc. Field Crops	12,100	12,309	125	125	---	---	240	227	607	607	197	197	648	613
Misc. Fruit & Nut	590	619	110	140	---	---	221	190	534	682	174	222	596	512
Misc. Vegetables	307	1,449	232	198	---	---	816	1110	1130	966	367	314	2200	2995
Other Non-specified ³	12,115	14,236	---	---	---	---	---	---	---	---	---	---	---	---

¹ Cultivated area for all crop categories was taken from Yolo County Agricultural Crop Reports.

² Inputs of Synthetic N and Agricultural Fuel (diesel) are taken from University of California Cooperative Extension cost and return studies.

³ Inputs and emissions from the "Other Non-specified" crop category were not included in the inventory, since data on input rates were unavailable.

3.5 Farmer Perceptions of Climate Change in Yolo County: What Drives their Inclination to Adopt Various Adaptation and Mitigation Practices?

V. R. Haden, M. Niles, M. Lubell, J. Perlman, and L. E. Jackson

Many factors affect farmers' perceptions and response to climate change; for example, characteristics of the individual farmer and their farm; social networks and involvement in programs run by local institutions, agricultural organizations, and extension services; and views on government programs and environmental policies. The goal of this subproject is to: (1) examine Yolo County farmers' perceptions of climate change and its risks to agriculture; and (2) develop a better understanding of how such factors might influence farmers' adoption of proposed adaptation and mitigation practices.

We conducted semi-structured interviews with eleven farmers and two agricultural extension workers in the fall of 2010. The sampling strategy recruited respondents from a cross section of farm sizes, local cropping systems, and market orientations. Interviewers followed a set of open-ended questions to minimize prompting and interviewer bias, and were used to develop a quantitative survey which was mailed to farmers in Yolo County during February and March of 2011. The survey sample was drawn from a list of 572 individuals who have submitted conventional or certified organic pesticide use permits to the Yolo County Agriculture Commissioner's office. The final response rate was 34.0 percent.

Results of the survey indicated that 54.4 percent of farmers agreed to some extent with the statement "the global climate is changing" (Table 3.3). A minority (21.3 percent) indicated that local summer temperatures had decreased over time, while only 5.6 percent observed an increase. While contrary to statewide mean temperatures, this corresponds with local climate records which show little change in maximum summer temperature over the last century (see Section 3.2).

A majority of farmers indicated that rainfall, drought, and flooding had not changed over the course of their career, but a sizable minority (43.0 percent) reported water availability had decreased and <1 percent said it had increased. In 1976, the newly constructed Indian Valley Reservoir began supplementing the District's surface water supplies to local growers. However, a recent drought in 2009 and 2010 reduced water releases in those years to less than 40 percent of the average for the preceding decade (1999–2008) (Yolo County Flood Control and Water Conservation District data, unpublished). The memory of this recent a drought may therefore occupy a central place in farmers' perception of water related trends.

Respondents with greater concern for drought and less reliable water (i.e., both surface and groundwater) were more likely to pump groundwater, drill new wells, and adopt drip irrigation (Table 3.4). A farmer's views on climate change affected the inclination to implement voluntary mitigation practices. More specifically, farmers who disagreed with the statement "The global climate is changing" were less likely to adopt mitigation practices than those who

Table 3.3. Perception of Past Trends in Local Summer Temperatures, Winter Temperatures, Annual Rainfall, Water Availability, Frequency of Drought, and Frequency of Flooding

Parameter	Perception of past trends in local climate, weather and water			
	Has increased over time	Has stayed the same over time	Has decreased over time	I don't know
	----- % of respondents -----			
Summer temperature (n = 160)	5.6	61.9	21.3	11.3
Winter temperature (n = 158)	7.6	70.3	8.9	13.3
Annual rainfall (n = 156)	3.2	69.2	15.4	12.2
Water availability (n = 158)	0.7	46.8	43.0	9.5
Frequency of drought (n = 157)	14.6	62	5.1	17.8
Frequency of flooding (n = 157)	3.2	65	14.6	17.2

n = number of respondents

agreed with the statement. Likewise, skepticism that human activities are an important cause of climate change meant less inclination to adopt mitigation practices. Farmers who had frequent contact with local agricultural organizations were more likely to implement mitigation strategies

Farmers are often more concerned about the future impact of government regulations than they are about the direct impacts of climate change. This ranking of concern is not surprising given the gradual nature of climate change. However, it does underscore the importance of understanding how farmers view environmental regulations and the information needed to influence their likelihood to adopt mitigation and adaptation practices. Strategies to expand the reach of local agricultural organizations and government conservation programs by improving farmer participation in their activities are thus seen as an important way to strengthen adaptation and mitigation efforts.

Table 3.4. Regression Coefficients for Future Climate Impact Concerns (1 = very concerned, 4 = not concerned) and the Inclination to Use Various Practices to Adapt to Water Scarcity (1 = very likely to adopt, 5 = very unlikely to adopt)

Adaptation practices	Climate Impact Concerns									
	Changing water resources			Changing temperatures				Changing markets and regulations		
	Severe droughts	Less reliable surface water	Less reliable ground-water	Warmer summer temps.	More heat waves	Fewer winter chill hours	More winter freezes	More volatile markets	Higher energy prices	More government regulations
Surface water on less acreage	0.01	0.11	0.07	-0.03	0.07	-0.09	-0.06	0.03	0.23*	0.19*
Pump more groundwater	0.15	0.27*	0.35*	0.13	0.10	0.07	0.13	0.11	0.24*	0.06
Drill wells or seek alternative water sources	0.19*	0.31*	0.19*	0.10	0.06	0.14	0.14	0.27*	0.21*	0.16*
Adopt drip irrigation	0.16	0.23*	0.23*	0.15	0.11	0.21*	0.24*	0.24*	0.19*	-0.05
Use drought tolerant varieties of my current crops	0.27*	0.16	0.14	0.18*	0.19*	-0.01	0.13	0.17*	0.19*	0.13
Change to less water intensive crops	0.07	0.13	0.06	-0.01	0.04	0.01	0.09	0.01	0.09	0.10
Make fewer cuts of hay or alfalfa	0.06	0.17	-0.02	0.16	0.08	0.14	0.19	0.04	-0.01	0.14
Move livestock to irrigated summer pasture earlier	-0.11	-0.01	0.04	-0.15	-0.08	-0.18	-0.18	-0.10	-0.05	-0.01
Reduce stocking rate for livestock	-0.06	-0.13	-0.10	-0.30†	-0.23	-0.30	-0.23	0.05	0.02	-0.05

*significant at $P < 0.05$

**significant at $P < 0.01$

3.6 Land Use Change, GHG Mitigation, Alternative Urban Growth Potential in Yolo County

S. Wheeler, M. Tomuta, V. R. Haden, J. Perlman, A. D. Hollander, and L. E. Jackson

California's Central Valley is one of the most productive agricultural regions in the world, yet it is facing some of the most rapid population growth in the state. Urbanization in California tends to consume lands with high quality soils and relatively abundant water supply due to their proximity to existing towns and cities in the valleys (American Farmland Trust 2010). The sub-project had the following objectives:

- Develop storylines for future urban growth that correspond to the IPCC's A2 and B1 scenarios, as well as an AB 32+ storyline that assumes continued, stronger state action in California to reduce GHG emissions. (Much of this scenario development was done during a previous phase of this study [Jackson et al. 2009]).
- Model urban growth between 2010 and 2050 for these scenarios using UPlan, a simple rule-based model used for regional or county-level modeling (Walker et al. 2007).
- Examine effects of this modeled growth on the farmland that is now used to grow particular crops in recent years, as well as on irrigated farmland in general.
- Calculate transportation-related and residential building-related GHG emissions from this new development for each scenario.

UPlan relies on a number of demographic inputs (e.g., current and future population, household size, employees per household, density of residential land use types, and floor-area per employee). Attractors (variables that would tend to attract urban growth) are given a positive value (e.g., in-fill areas). Discouragements (variables that would tend to discourage urban growth) are given negative values (e.g., steep slopes). A system of weights is used to rank the attractive or discouraging property of each variable. We modified UPlan to allow development within existing urban areas, on the assumption that a significant urban redevelopment is likely within the 2010–2050 timeframe.

The A2 scenario loses two times more acreage of high quality soils to urbanization compared to B1 (Figure 3.7; Table 3.5). One of the most striking findings is just how little land is required to house future populations at higher densities. The B1 and AB 32+ scenarios require 44 percent and 7 percent of the urbanized land of the A2 scenario, respectively. Even holding population increase constant at B1 levels, these scenarios use 63 percent and 38 percent of the land of the A2 scenario, most or all of it within existing urban areas, and also greatly reduce GHG emissions from transportation. These results suggest that the most important climate change mitigation policy that Yolo County could adopt would be to restrict urban development to infill locations within existing cities, and to keep existing farmland in agriculture.

Fragmentation and loss of farmland causes farmers to lose benefits associated with being part of a large farming community, such as sourcing inputs, accessing information, sharing equipment,

and supporting processing and shipping operations (Porter 1998). This is further exacerbated by loss of agricultural land near the Sacramento River, either due to future flooding or to mitigation of habitat for wild species. Also, by fragmenting the landscape and consuming more land area in the floodplain, urbanization in the A2 scenario could work against the provision of ecosystem services related to water quality, biodiversity conservation, open space and its aesthetic and recreational value (Gutman 2007). Strengthening the urban community's interest and support of farmland preservation is a key challenge for mitigation of GHG emissions, and the long-term viability of agriculture in Yolo County.

Yolo County Climate Change Adaptation Project
A2 Regional Enterprise Storyline

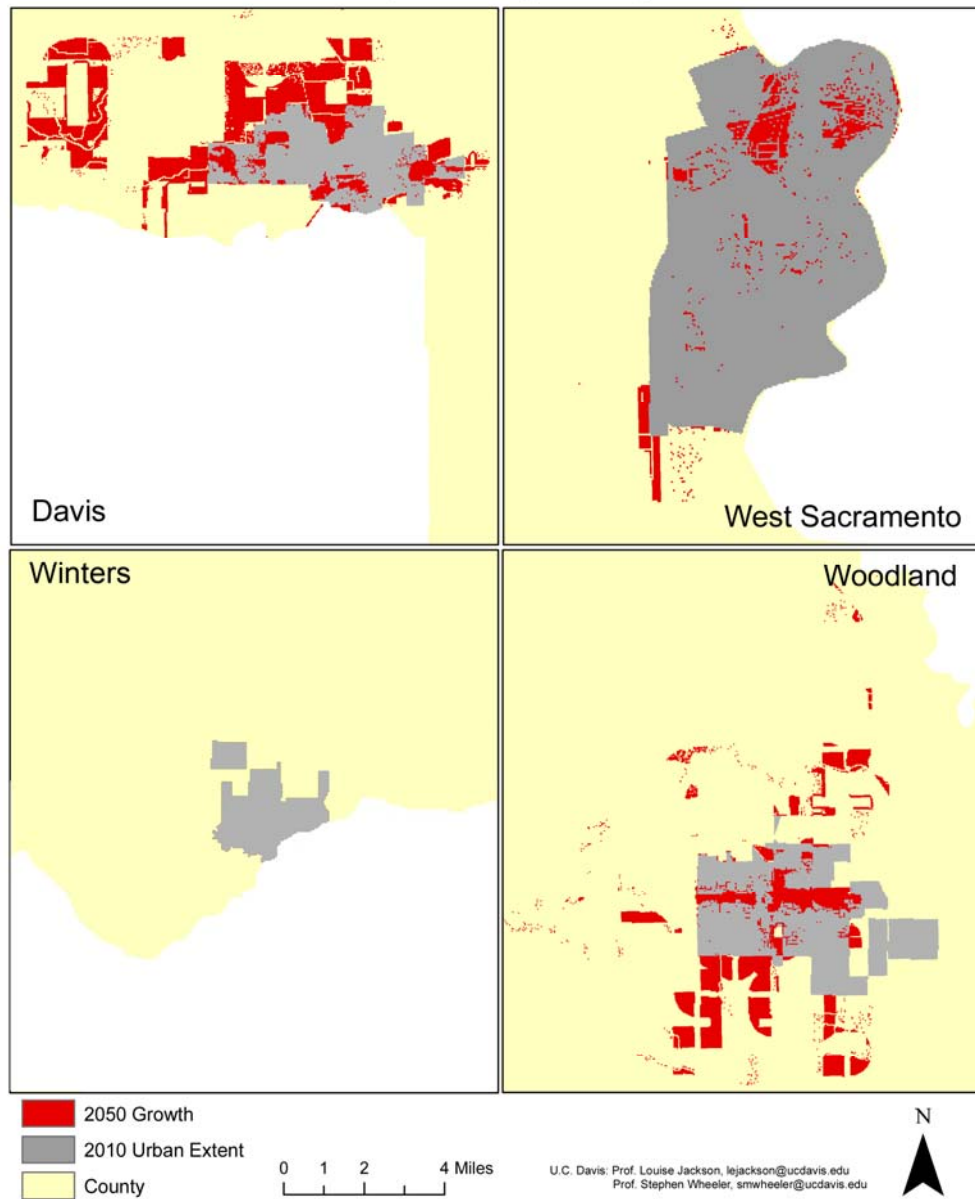

Figure 3.7. Urban Growth in Yolo County, 2010–2050, A2 Scenario, Detail of Cities

Table 3.5. Summary of Specific Crops and Acres Lost to Urbanization under Each Storyline. Note that pasture refers to upland, non-irrigated grazing lands and savanna. Only forest, grassland, and pastures are typically non-irrigated.

2050 Agricultural Acreage Consumed by Urban Development			
Type of Crop or Agroecosystem	A2	B1	AB 32+
	----- acres -----		
Alfalfa	2,329	621	2
Almond and Pistachio	81	2	-
Barren	28	3	-
Corn	505	167	-
Cucurbits	13	-	-
Dry Beans	85	54	1
Fallow	170	25	-
Forest	-	-	-
Grain	1,422	471	-
Grassland	67	48	1
Onions and Garlic	68	2	-
Other Deciduous Trees	107	83	-
Other Field Crops	1,358	366	-
Other Subtropical Crops	2	-	-
Other Truck Crops	23	3	-
Pasture	1,629	514	15
Processing Tomato	1,958	704	4
Rice	-	-	-
Safflower	515	258	-
Vine	203	40	-
TOTAL	10,562	3,363	23

3.8 Conclusions from the Yolo County Case Study

From this study we can draw the following broad conclusions:

- Over the past 100 years, local records show small increases in both winter (0.8°C–1.0°C, or 1.4°F–1.8°F) and summer (0.5°C–0.7°C, or 0.9°F–1.3°F) temperatures. The somewhat larger increase in winter temperatures has meant that climate has had more influence on acreage decisions for crops affected by winter/early spring conditions (wheat, alfalfa, tomato, prunes, walnuts, and other miscellaneous fruits). Future acreage projections, based on these historical relationships and the GFDL general circulation model, indicate that warmer winter temperatures will favor vegetable crops (e.g., tomatoes) over field crops (e.g., wheat).
- Water is arguably the most important agricultural resource in Yolo County and throughout California. Given the uncertainty regarding the magnitude of future climate change and its impact on water resources, strategies to manage local water supplies in light of climate change must be developed with the input of multiple stakeholders. Promising strategies are likely to include adopting more diverse and water-efficient cropping systems, investing in water saving technologies, and developing conjunctive use strategies to safeguard surface and groundwater supplies.
- Agriculture plays a modest role in Yolo County’s GHG emissions. Agricultural activities occur on approximately 87 percent of the land area, but are estimated to produce only 14 percent of total county-wide GHG emissions in 1990. Local efforts to integrate on-farm mitigation strategies with local policies to preserve farmland and promote smart growth within existing urban boundaries can help stabilize and mitigate future emissions.
- Strategies to expand the reach of local agricultural organizations and government conservation programs by improving farmer participation in their activities are thus seen as an important way to strengthen adaptation and mitigation efforts. Improved methods and programs to share relevant information and applied research are crucial to successful adaptation and mitigation. Some types of information will be relevant to farmers across California, but there is also a need for place-based, regional problem-solving that is supported within rural communities.
- Strengthening connections at the rural-urban interface will generate greater awareness among urban dwellers for the ecosystem services provided on agricultural lands (food and fiber, environmental resources, biodiversity conservation, livelihood options, and business opportunities that build social capital) and their vulnerability to climate change. Stronger rural-urban connections are necessary for achieving consensus for farmland protection via zoning, urban growth boundaries, and infill development.

3.7 References

- Adger, W. N. 2003. "Social capital, collective action, and adaptation to climate change." *Economic Geography* 79: 387–404.
- American Farmland Trust. 2010. California Agricultural Vision: Strategies for Sustainability. 32 pp. <http://www.cdfa.ca.gov/agvision/>.
- ARB. 2009. *California's 1990–2004 Greenhouse Gas Emissions Inventory and 1990 Emissions Level: Technical Support Document*. California Environmental Protection Agency, Air Resources Board, Sacramento, California.
- Baldocchi, D., and S. Wong. 2008. "Accumulated winter chill is decreasing in the fruit growing regions of California." *Climatic Change* 87: 153–166.
- CAGO. 2009. *Climate Change, the California Environmental Quality Act, and General Plan Updates: Straightforward Answers to Some Frequently Asked Questions*. California Attorney General's Office, Sacramento, California.
- Cayan, D. R., E. P. Maurer, M. D. Dettinger, M. Tyree, and K. Hayhoe. 2008. "Climate change scenarios for the California region." *Climatic Change* 87(1): S21–S42.
- Dukes, J. S., N. R. Chiariello, E. E. Cleland, L. A. Moore, M. R. Shaw, S. Thayer, T. Tobeck, H. A. Mooney, and C. B. Field. 2005. "Responses of grassland production to single and multiple global environmental changes." *PLoS Biology* 3(10): 1829–1837.
- Fitzgerald, G. J., K. M. Scow, and J. E. Hill. 2000. "Fallow season straw and water management effects on methane emissions in California rice." *Global Biogeochemical Cycles* 14: 767–776.
- Gutman, P. 2007. "Ecosystem services: Foundations for a new rural–urban compact." *Ecological Economics* 62(3-4): 383–387.
- Hettinger, K. 2011. "New frontier in urban greenhouse gas emissions regulation: Overview of California's Senate Bill 375." *Sustainable Development Law and Policy* 11: 58–59.
- IPCC. 2006. IPCC Guidelines for National Greenhouse Gas Inventories. Prepared by the National Greenhouse Gas Inventories Program. H. S. Eggleston, L. Buendia, K. Miwa, T. Ngara, and K. Tanabe (eds). IGES: Japan.
- Jackson, L. E., F. Santos-Martin, A. D. Hollander, W. R. Horwath, R. E. Howitt, J. B. Kramer, A. T. O'Geen, B. S. Orlove, J. W. Six, S. K. Sokolow, D. A. Sumner, T. P. Tomich, and S. M. Wheeler. 2009. *Potential for adaptation to climate change in an agricultural landscape in the central valley of California*. California Climate Change Center Report. Publication number: CEC-500-2009-044-F.
- Jackson, L. E., S. M. Wheeler, A. D. Hollander, A. T. O'Geen, B. S. Orlove, J. W. Six, D. A. Sumner, F. Santos-Martin, J. B. Kramer, W. R. Horwath, R. E. Howitt, T. P. Tomich. 2011.

- “Case study on potential agricultural responses to climate change in a California landscape.” *Climatic Change* 109 (Suppl 1): S407–S427.
- Jackson, L. E., V. R. Haden, A. Hollander, H. Lee, M. Lubell, V. Mehta, T. O’Geen, M. Niles, J. Perlman, D. Purkey, W. Salas, D. Sumner, M. Tomuta, M. Dempsey, and S. Wheeler. 2012. *Adaptation Strategies for Agricultural Sustainability in Yolo County, California*. California Energy Commission. Publication number: CEC-500-2012-032.
- Joyce, B., V. Mehta, D. Purkey, L. Dale, and M. Hanemann. 2009. *Climate Change Impacts on Water Supply and Agricultural Water Management in California’s Western San Joaquin Valley, and Potential Adaptation Strategies*. California Climate Change Center. Report no. CEC-500-2009-051-F.
- Long, Rachael. 2010. Proceedings of the California Alfalfa and Forage Symposium and Corn/Cereal Silage Conference. Visalia, California. 1–2 December, 2010.
- Medellín-Azuara, J., J. J. Harou, M. A. Olivares, K. Madani, J. R. Lund, R. E. Howitt, S. K. Tanaka, M. W. Jenkins, and T. Zhu. 2008. “Adaptability and adaptations of California’s water supply system to dry climate warming.” *Climatic Change* 87(1): 75–90.
- Moore, M. T., D. L. Denton, C. M. Cooper, J. Wrynski, J. L. Miller, K. Reece, D. Crane, and P. Robins. 2008. “Mitigation assessment of vegetated drainage ditches for collecting irrigation runoff in California.” *Journal of Environmental Quality* 37: 486–493.
- Porter, M. E. 1998. “Clusters and the new economics of competition.” *Harvard Business Review* 76(6): 77–90.
- Purkey, D., A. Huber-Lee, D. Yates, M. Hanemann, and S. Herrod-Julius. 2007. “Integrating a Climate Change Assessment Tool into Stakeholder-Driven Water Management Decision-Making Processes in California.” *Water Resources Management* 21: 315–329.
- Purkey, D. R., B. Joyce, S. Vicuna, M. W. Hanemann, L. L. Dale, D. Yates, and J. A. Dracup. 2008. “Robust analysis of future climate change impacts on water for agriculture and other sectors: A case study in the Sacramento Valley.” *Climatic Change* 87: 109–122.
- Shaw, M. R., E. S. Zavaleta, N. R. Chiariello, E. E. Cleland, H. A. Mooney, and C. B. Field. 2002. “Grassland Responses to Global Environmental Changes Suppressed by Elevated CO₂.” *Science* 298: 1987–1990.
- USEPA. 2004. *Emission Inventory Improvement Program*. Technical Report Series, Volume 8: Estimating Greenhouse Gas Emissions. U.S. Environmental Protection Agency, Washington, D.C.
- U.S. EPA. 2010. *Inventory of U.S. Greenhouse Gas Emissions and Sinks 1990–2008*. U.S. Environmental Protection Agency, Washington, D.C.
- Walker, W. T., S. Gao, and R. A. Johnston. 2007. “UPlan: Geographic information system as framework for integrated land use planning model.” *Transportation Research Record* 1994. 117–127.

- WRA (Water Resources Association). 2005. Yolo County Integrated Regional and Water Management Plan: Background Data and Information Appendix. 412.
- Yates, D., J. Sieber, D. Purkey, and A. Huber-Lee. 2005a. "WEAP21: A demand, priority, and preference-driven water planning model." *Water International* 30(4): 487–500.
- Yates, D., D. Purkey, J. Sieber, A. Huber-Lee, and H. Galbraith. 2005b. "WEAP21: A demand, priority, and preference-driven water planning model: Part 2, Aiding freshwater ecosystem service evaluation." *Water International* 30(4): 501–512.
- Yolo County. 2010. Yolo County Climate Action Plan: A Strategy for Smart Growth Implementation, Greenhouse Gas Reduction, and Adaptation to Global Climate Change. Yolo County, Woodland, California.
- Young-Mathews, A., S. W. Culman, S. Sánchez-Moreno, A. T. O'Geen, H. Ferris, A. D. Hollander, and L. E. Jackson. 2010. "Plant-soil biodiversity relationships and nutrient retention in agricultural riparian zones of the Sacramento Valley, California." *Agroforestry Systems* 80: 41–60.

4.0 Urban Growth Scenarios, Land Use, and Farmland Loss

S.M. Wheeler, V.R. Haden, A.D. Hollander, and J. Perlman

4.1 Introduction and Background on Urbanization of Farmland in California

Historically, urban and suburban development has covered many regions within California that were formerly leading agricultural producers, including the Los Angeles Basin and Orange County, much of the San Francisco Bay Area, and areas of the Central Valley near Fresno, Modesto, Merced, Sacramento, and Stockton. Between now and the year 2050 much additional urbanization is likely near these metropolitan areas, as well as in locations that are at a considerable distance from existing major cities, such as the Salinas Valley and Ventura County.

Strategies to preserve agricultural land from urbanization are likely to dovetail with strategies to adapt to climate change and mitigate greenhouse gas (GHG) emissions, reducing the state's overall vulnerability to climate change. For example, maintaining a strong greenbelt of agricultural land around existing urban areas and adopting compact urban development policies can greatly reduce GHG emissions (as described in the Yolo County case study in Section 2), while preserving agricultural production and potentially enhancing ecosystem services.

This section considers urbanization implications related to agriculture and climate change, based on statewide modeling of 2050 urban growth scenarios, using existing datasets regarding agricultural production, land use, and soils. Climate projections are not included here, but could be included in future analyses. The actual complexities of urban-agriculture interactions require a great deal of monitoring and interdisciplinary synthesis that is beyond our scope, e.g., urban heat island or ozone effects may lead to additional vulnerabilities for agriculture with climate change. Our aim here is instead to present an initial overview of potential agricultural adaptation and vulnerability effects related to urbanization, and to suggest directions for further research.

The strong policy framework in California for GHG mitigation under AB 32, the Global Warming Solutions Act of 2006, has drawn attention to the fact that California's urban planning framework is in a state of uncertainty and potential transition. SB 375, the Sustainable Communities and Climate Protection Act of 2008, requires Metropolitan Planning Organizations (MPOs) within the state to prepare "sustainable communities strategies" (SCSs) that show how each region will meet GHG-reduction targets through integrated land use, housing, and transportation planning. As of 2011, MPOs are just beginning to develop such plans. SB 375 is widely seen as having the potential to usher in a new era of land use planning in California, in which regional "blueprints" will be adopted to manage and reduce urban and suburban expansion (Bedsworth et al. 2011). However, it is by no means clear how the

California Air Resources Board (which is charged with overseeing implementation of the SCSs) or the legislature will react to ensure that such potential is in fact met.

In addition, as of 2010 every county and municipality in the state must now consider GHG emissions (which are strongly influenced by land use planning) within their General Plans and associated Environmental Impact Reports (SMAQMD 2011). Since 2007, the state Attorney General's office has frequently threatened legal action against those jurisdictions that do not include planning alternatives to reduce GHG emissions (CAGO 2009). The California Air Resources Board is also strongly encouraging local governments and large institutions to prepare Climate Action Plans and GHG emissions inventories, and many have already done so. These actions mean that local governments are now more actively exploring land use planning alternatives to mitigate GHG emissions and adapt to climate change. Although political resistance to growth management will certainly continue, such trends mean that in the future the state's local governments are more likely to consider growth management scenarios that respond to the twin goals of preserving agricultural land and responding to climate change. This institutional and political environment affects our analysis below, and will be referred to when appropriate.

4.2 Approach and Methods for Statewide Urbanization Scenarios

To analyze the impact of future urbanization scenarios on agricultural landscapes within California within the context of climate change, we relied on modeling done by the UC Davis Information Center for the Environment (ICE) using UPlan software (Thorne et al. 2012) under a separate portion of this Climate Change Vulnerability and Adaptation Study for California. We then performed additional analyses on the UPlan projections for 2050, using statewide data on agriculture, land use, and soils.

UPlan is a geographic information system (GIS)-based land use allocation model developed by ICE and used for urban planning purposes by more than 20 counties in California, including a number of rural counties in the San Joaquin Valley (Johnston et al. 2004). It is particularly useful for large-scale urban growth scenarios in rural areas, and has been used in a research context to analyze urbanization effects on natural resources (Beardsley et al. 2009), urbanization effects on wildfire risk (Byrd et al. 2009), and the effect of land use policies on natural land conversion (Merenlander et al. 2005).

Using UPlan, researchers first develop a base of GIS information related to geographical features such as roads, rivers and streams, floodplains, parkland, and existing urban areas. They then supply demographic inputs (such as current and future population, household size, employees per household, proportion of population by land use type, density of residential land use types, and floor-area per employee within commercial development) within future urban growth scenarios. Researchers also specify geographical features that are likely to attract urban growth ("attractors"), discourage growth ("discouragers"), or prevent growth ("masks"), and assign weightings to each. For example, freeway interchanges may attract development, since builders desire the locational advantages. Designation as prime farmland may discourage development, since local governments may take this factor into account within their zoning and

growth management policymaking, and farmers may participate in the Williamson Act or other programs designed to discourage urbanization. Acquisition of land as public open space will prevent urbanization altogether, thus making a “mask” designation appropriate within UPlan.

Relying on the combined weightings for each 50-meter grid cell, UPlan allocates the future population increase across four residential land use types (corresponding to High, Medium, Low, and Very Low density development), and several nonresidential land use types (such as Commercial High Density, Commercial Low Density, and Industrial). The result is a spatial projection of future urbanization with designations for each land use type.

ICE staff developed two main UPlan scenarios for statewide mapping within this project (Thorne et al. 2012). One represents a “business as usual” (BAU) scenario of urban development. The other is a “smart growth” (SG) alternative that clusters development into nodes, specifies somewhat higher densities, and places more development within existing city borders. Such scenarios reflect growth management philosophies within the state during recent decades; many local and regional planning agencies have developed similar alternatives within their own planning processes.

The ICE SG scenario is relatively conservative and does not assume any dramatic changes to current planning policies. In reality, over the past two decades, development within the state near large metropolitan areas has become increasingly compact and focused on infill sites (i.e., within the existing urban area) rather than greenfield locations (i.e., agricultural land and open space outside the urban envelope) (e.g., Greenbelt Alliance 2008). This trend is due to the following factors:

- Increasing land prices (which lead builders to construct housing at higher densities to keep per-unit costs down)
- Increasing scarcity of vacant land in urban areas such as the Los Angeles Basin and the inner San Francisco Bay Area (which provides an incentive for developers to re-use existing urban parcels)
- Changes in public policy (which increasingly encourages denser development and infill development, and often seeks to protect agricultural land)
- Market preference (i.e., increasing numbers of young professionals, empty nesters, and retirees wanting to live in walkable locations near urban amenities) (Thomas 2009)

In the 2050 timeframe, it is likely that this trend will continue, especially if further encouraged by legislation such as SB 375 and associated local and regional planning. Therefore, future land use policy debates in California are likely to consider even denser, more infill-oriented development scenarios than the SG alternative analyzed here. A larger percentage of new residential commercial and residential development would then occur inside existing urban areas, meaning that larger amounts of agricultural land would be preserved from development. ICE is currently modeling such an Infill Scenario, but this was unavailable for detailed analysis at the time of this study. Our analysis below does, however, consider the general implications of

an Infill Scenario in terms of reducing agricultural vulnerability to climate change and limiting GHG emissions.

We compared the modeled BAU and SG urbanization scenarios for California in 2050 with statewide land use coverages mapped in the California Augmented Multi-purpose Land-cover (CAML) dataset (Hollander 2007) and the USDA-NRCS Soil Survey Geographic Database (SSURGO) (Soil Survey Staff 2006) (see Section 1) to determine the following:

1. Amounts of existing agricultural, natural, and urban land within each of nine California regions that would be covered by different types of new urban development in each scenario
2. Amounts of farmland of different soil land capability classes within each region that would be urbanized under each scenario

These analyses allowed us to determine where greatest urbanization impacts are likely to occur on agricultural and on natural lands within various regions (Figure 4.1), and to what extent high-value agricultural land would be lost. The regional boundaries are based on groups of counties that share similar geographical characteristics that are relevant to broad patterns of urbanization and agricultural production. The boundaries are not meant to follow official regional jurisdictions, though in some cases they do coincide (e.g., the Sacramento Area Council of Governments [SACOG] region and the Association of Bay Area Governments [ABAG] region).

The analysis also drew upon our more detailed case study of Yolo County (see Section 3) where UPlan was used to model three different urban growth scenarios for 2050. Spatial maps of potential urbanization at higher resolution enabled us to see, for example, the degree of fragmentation of agricultural land under a business-as-usual scenario. That project also produced GHG emissions projections for different urbanization scenarios that are useful to keep in mind when contemplating statewide policy options.

Lastly, we analyzed urbanization impacts in light of the recent literature on urban growth management, especially regarding specific regulatory tools currently used or proposed in California, to determine particular policy strategies that might minimize agricultural landscape vulnerability to urbanization in the context of climate change. These potential policy strategies are presented in Table 4.5.

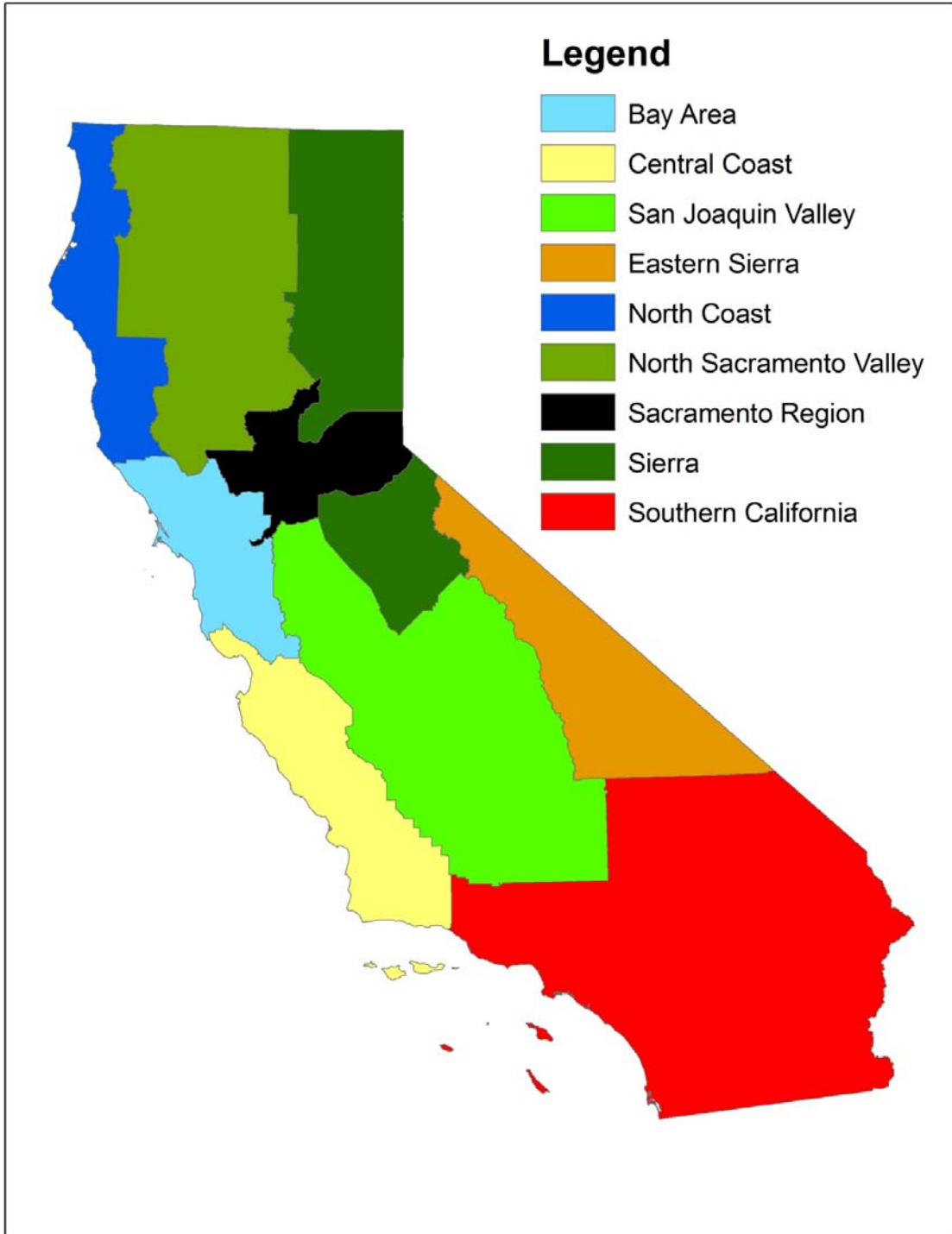

Figure 4.1. Urban Growth Analysis Areas Statewide. The regional boundaries are based on groups of counties that share similar geographical characteristics that are relevant to broad patterns urbanization and agricultural production. The boundaries are not meant to follow official regional jurisdictions, though in some cases they do coincide (e.g., the Sacramento Area Council of Governments [SACOG] region and the Association of Bay Area Governments [ABAG] region).

4.3 Results of Urbanization Scenarios on Farmland Loss

4.3.1 Quantities of Agricultural Land Lost to Urbanization by 2050

Overall, both urban development scenarios consume significant amounts of California farmland by 2050 (Figures 4.2 and 4.3). The BAU alternative urbanizes approximately 7,096 square kilometers (km²) of farmland, 10 percent of the total, while the SG option builds on approximately 5,717 km², 8 percent of the total.

Within particular regions of the state the impact of urbanization on agricultural land is likely to be somewhat greater. Within the Sacramento region (including Stockton and the Marysville/Yuba City area), UPlan projects new urban development within the BAU scenario to cover 809 square kilometers of agricultural land, or about 13 percent of total remaining farmland in that geographical area (Tables 4.1 and 4.2; Figures 4.2 and 4.3). The SG alternative is projected to consume 624 km², or 10 percent, of farmland. Within the Southern California region, urban development is expected to consume 10 percent or 9 percent of remaining farmland by 2050, depending on the scenario. In the San Joaquin Valley, new urbanization is projected to cover 12 percent or 9 percent of agricultural land. Within the San Francisco Bay Area, those numbers are 9 percent or 7 percent, respectively.

Both the BAU and SG scenarios show by far the greatest amount of urbanization occurring in the Central Valley (Tables 4.1 and 4.2; Figures 4.2 and 4.3). For the BAU scenario, a total of 8,478 km² (67 percent of total statewide urbanization) occurs in the Central Valley as a whole. The SG scenario locates a smaller amount but a similar percentage of development in the Central Valley, 9,578 km², 67 percent of total statewide urbanization under that alternative.

4.3.2 Areas of Class I and Class II Soils Lost to Urbanization by 2050

Within the USDA's Land Capability Classification System, soils are grouped according to capability to produce crops and pasture animals without degradation over time. Class I and Class II soils are the most important for agriculture, having few or only modest limitations for production capacity, respectively. Statewide, California has 6,609 and 20,546 square kilometers, respectively, of these soil types (Wohletz and Dolder 1952).

Under the BAU scenario for 2050, urbanization would consume about 5,281 km² of Class I and II soils in the state, or about 19 percent of total soils in these categories (Table 4.3). About 28 percent of new urban development would be located on such soils. By far the largest amount of Class I and II soils urbanized, 41 percent of the total, would be located in the San Joaquin Valley, with a significant amount (33 percent) located in Southern California.

Under the SG scenario, new urban development would cover approximately 4,442 km² of Class I and II soils, or about 16 percent of statewide soils within these groupings (Table 4.4). Approximately 29 percent of new urban development would be located on such soils, about the same as in the BAU scenario. Again the San Joaquin Valley and Southern California account for by far the largest share of Class I and II soils urbanized, 41 percent and 36 percent of the total, respectively (See Table 4.3).

Urban growth as modeled by Uplan for business as usual scenario

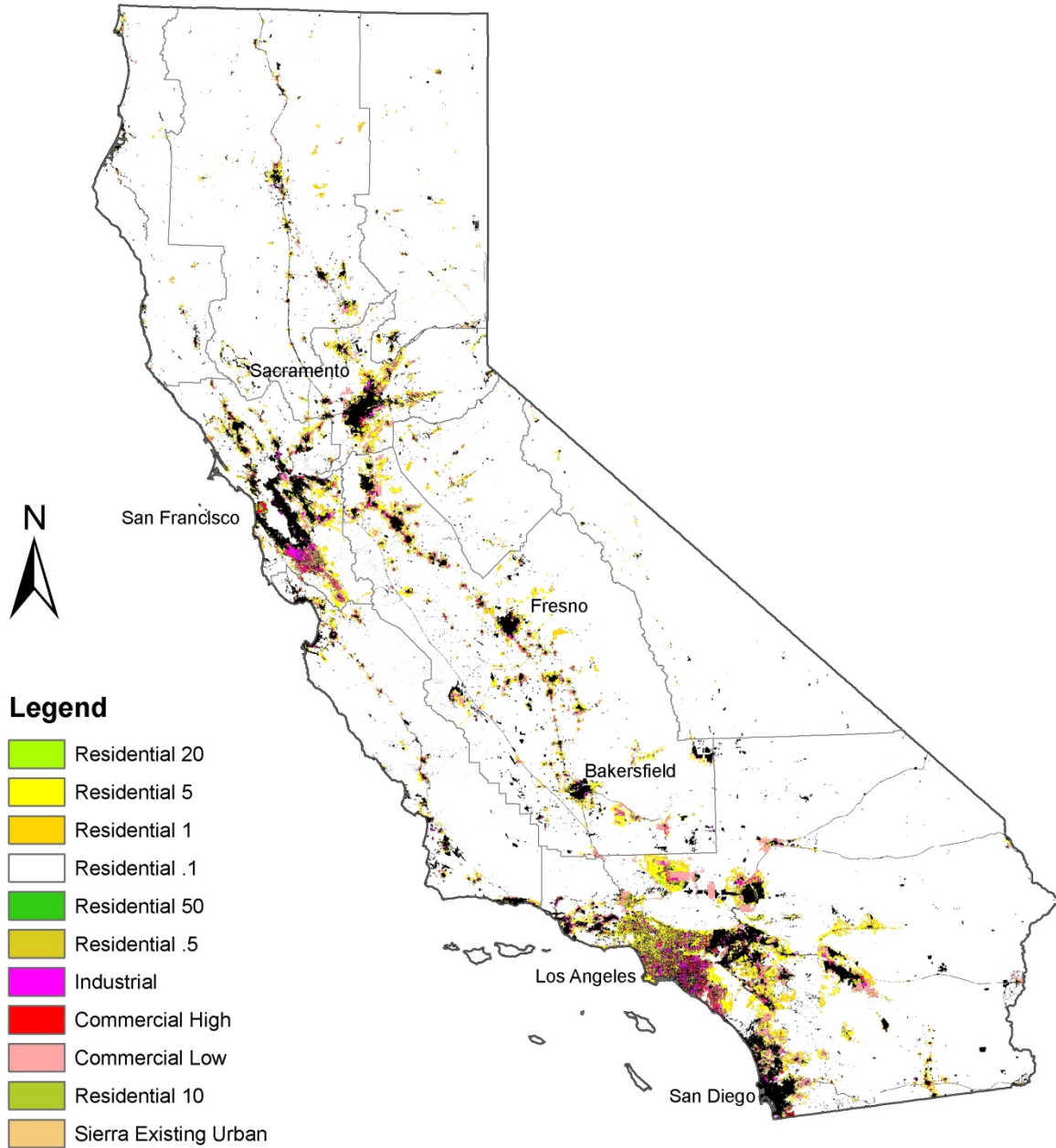

NOTE: The urban category "Residential .1" is too dispersed to be seen in a representative manner on the map. Black areas represent existing urban areas.

Figure 4.2. Urban Growth Statewide as Modeled by UPlan for BAU Scenario

Urban growth as modeled by Uplan for smart growth scenario

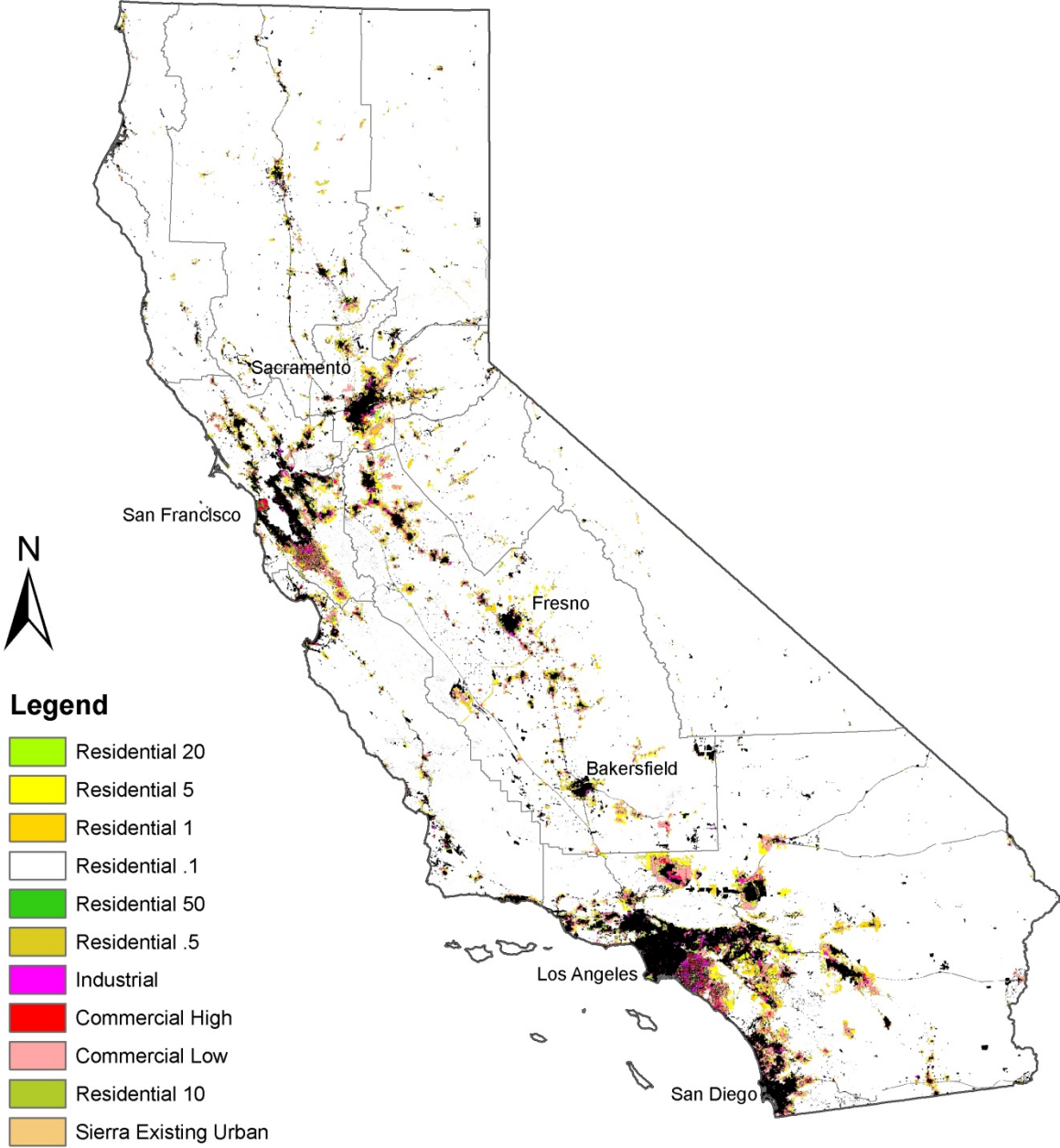

NOTE: The urban category "Residential .1" is too dispersed to be seen in a representative manner on the map. Black areas represent existing urban areas.

Figure 4.3. Urban Growth Statewide as Modeled by UPlan for SG Scenario

Table 4.1. Previous and Future Uses of Farmland Areas Converted to Urban by 2050 under UPLAN Business as Usual Scenario. Agricultural, natural, and urban land use categories were derived from the California Augmented Multipurpose Landcover (CAML) geospatial database.

Prev. Land Use	Area converted to urban under UPLAN business as usual scenario										Total
	New Urban	Bay Area	Cen. Coast	SJ Valley	N.Coast	N. Valley	Sac. Reg.	Sierra	E. Sierra	S. Cal.	
	----- km2 -----										
Agriculture	Res 5	182	36	648	3	16	157	4	5	501	1,552
	Res 1	67	58	513	12	40	149	12	8	204	1,063
	Res .1	149	76	1406	17	302	320	48	16	283	2,619
	Ind	14	4	74	0	1	9	0	0	66	168
	Comm H	18	3	44	0	1	13	0	0	41	120
	Comm L	162	61	538	3	22	144	1	4	498	1,433
	Res 20	10	1	53	0	2	17	0	0	55	139
	SEU	-	-	-	-	-	-	1	-	-	1
	Total	602	239	3,276	36	385	809	67	33	1,648	7,096
	Total Ag	6,424	4,347	27,334	799	6,730	6,316	2,822	305	16,966	72,043
	% of Ag	9%	6%	12%	5%	6%	13%	2%	11%	10%	10%
Natural	Res 5	427	74	307	10	62	216	33	2	1410	914
	Res 1	149	46	164	25	140	177	98	4	805	623
	Res .1	388	284	1184	134	372	477	335	5	795	2,698
	Ind	33	6	12	1	5	18	2	0	93	59
	Comm H	31	5	14	1	4	19	3	0	69	58
	Comm L	248	35	226	12	53	148	25	2	960	599
	Res 20	36	9	30	2	8	21	2	2	168	87
	SEU	-	-	-	-	-	-	3	-	-	3
	Total	1,311	460	1,936	184	644	1,078	501	15	4,300	5,041
	Total Nat.	11,785	24,176	43,855	20,243	49,915	10,671	48,102	34,318	93,661	336,726
	% of Nat.	11%	2%	4%	1%	1%	10%	1%	0%	5%	1%
Urban	Res 5	48	12	71	2	14	56	1	0	286	147
	Res 1	6	3	22	3	9	7	3	0	16	43
	Res .1	4	3	7	0	2	2	0	0	3	17
	Ind	41	3	23	0	1	10	0	0	100	69
	Comm H	25	4	13	0	2	6	0	0	106	44
	Comm L	61	14	50	1	8	20	2	0	238	136
	Res 20	37	4	17	0	3	6	0	0	111	63
	SEU	-	-	-	-	-	-	5	-	-	5
	Total	223	44	203	7	40	107	13	0	861	524
	Total Urb.	3,491	1,235	3,226	275	870	1,664	351	74	11,191	22,377
	% of Urb.	6%	4%	6%	3%	5%	6%	4%	0%	8%	2%
TOTAL NEW URBAN		2,137	743	5,415	227	1,069	1,994	582	48	6,808	12,661
TOTAL LAND		21,700	29,758	74,415	21,317	57,515	18,651	51,275	34,697	121,818	431,146
% OF TOTAL LAND		10%	2%	7%	1%	2%	11%	1%	0%	6%	3%

Table 4.2. Previous and Future Uses of Farmland Areas Converted to Urban by 2050 under Upland Smart Growth Scenario. Agricultural, natural, and urban land use categories were derived from the California Augmented Multipurpose Landcover (CAML) geospatial database.

Prev. Use	New Urban	Bay Area	Cen. Coast	SJ Valley	N. Coast	N. Valley	Sac. Reg.	Sierra	E. Sierra	S. Cal.	Total	
		----- km2 -----										
Agriculture	Res 5	115	21	406	2	11	124	2	3	344	1,029	
	Res 1	54	42	467	11	36	110	13	7	189	928	
	Res .1	76	45	847	10	183	193	30	9	187	1,581	
	Res 50	1	0	5	0	0	1	0	0	3	10	
	Res .5	9	7	80	1	10	15	2	1	36	160	
	Ind	21	4	73	0	1	9	0	0	55	163	
	Comm H	16	3	43	0	1	13	0	0	57	133	
	Comm L	111	38	538	3	22	133	1	4	542	1,392	
	Res 10	14	2	50	0	1	8	0	0	50	126	
	Res 20	16	2	70	0	2	19	0	0	83	193	
	SEU	-	-	-	-	-	-	-	1	1	-	1
	Total	433	165	2,579	28	267	624	49	25	1,547	5,717	
Total Ag	6,424	4,347	27,334	799	6,730	6,316	2,822	305	16,966	72,043		
% of Ag	7%	4%	9%	3%	4%	10%	2%	8%	9%	8%		
Natural	Res 5	268	49	198	7	42	121	25	2	976	1,687	
	Res 1	102	46	129	22	121	162	82	3	622	1,288	
	Res .1	246	171	707	81	222	285	201	3	529	2,446	
	Res 50	2	1	2	0	1	1	0	0	16	23	
	Res .5	12	8	22	4	16	17	13	0	18	110	
	Ind	38	6	13	1	5	19	2	0	143	227	
	Comm H	30	5	14	1	4	19	3	0	103	180	
	Comm L	313	61	221	12	54	155	25	2	1005	1,848	
	Res 10	40	7	26	1	6	19	3	1	154	257	
	Res 20	46	11	39	2	10	32	4	2	214	359	
	SEU	-	-	-	-	-	-	-	3	-	-	3
	Total	1,098	364	1,371	131	480	830	362	13	3,779	8,428	
Total Nat.	11,785	24,176	43,855	20,243	49,915	10,671	48,102	34,318	93,661	336,726		
% of Nat.	11%	2%	4%	0%	0%	40%	1%	1%	1%	3%		
Urban	Res 5	20	7	43	1	9	25	1	0	61	168	
	Res 1	31	5	15	3	9	11	3	0	21	98	
	Res .1	3	2	4	0	1	1	0	0	2	13	
	Res 50	5	0	2	0	0	1	0	0	7	16	
	Res .5	1	0	2	0	1	0	0	0	2	7	
	Ind	30	2	23	0	1	10	0	0	63	130	
	Comm H	28	4	13	0	2	6	0	0	48	102	
	Comm L	48	11	51	1	8	24	2	0	183	329	
	Res 10	11	3	27	0	2	15	0	0	21	79	
	Res 20	34	5	22	0	3	7	0	0	73	145	
	SEU	-	-	-	-	-	-	-	5	-	-	5
	Total	211	41	201	7	37	102	12	0	479	1,091	
Total Urb.	3,491	1,235	3,226	275	870	1,664	351	74	11,191	22,377		
% of Urb.	6%	3%	6%	2%	4%	6%	3%	0%	4%	5%		
TOTAL NEW URBAN	1,742	541	4,008	37	162	5,408	765	415	1,491	14,411		
TOTAL LAND		21,700	29,758	74,415	21,317	57,515	18,651	51,275	34,697	121,818	431,146	
% OF TOTAL LAND		8%	2%	5%	0%	0%	29%	1%	1%	1%	3%	

Table 4.3. Area Converted to Urban by 2050 under UPlan Business as Usual Scenario. The SSURGO soil dataset was used to determine land capability classes.

Area converted to urban under UPLAN business as usual scenario										
Soil Class	Bay Area	Cen. Coast	SJ Valley	N. Coast	N. Valley	Sac Reg.	Sierra	E. Sierra	S. Cal.	Statewide
----- km ² -----										
Class 0	751	131	1119	166	398	379	285	16	3094	6,339
Class I	189	94	905	18	87	97	2	0	299	1,692
Class II	315	95	1276	15	147	290	10	7	1434	3,590
Class III	232	84	1360	21	179	512	47	18	971	3,426
Class IV	273	91	535	4	151	479	169	7	675	2,384
Class V	0	0	0	0	70	0	0	0	0	71
Class VI	269	125	168	0	18	232	54	0	240	1,107
Class VII	103	101	49	0	17	5	13	0	92	379
Class VIII	7	20	3	0	1	0	0	0	0	31
TOTAL	2,139	742	5,415	225	1,069	1,994	581	48	6,805	19,018

Table 4.4. Previous and Future Uses of Farmland Areas Converted to Urban by 2050 under UPLAN Smart Growth Scenario. The SSURGO soil dataset was used to determine land capability classes.

Area converted to urban under UPLAN Smart Growth scenario										
Soil Class	Bay Area	Cen. Coast	SJ Valley	N. Coast	N. Valley	Sac. Reg.	Sierra	E. Sierra	S. Cal.	Statewide
----- km ² -----										
Class 0	593	103	802	115	279	294	211	13	2504	4,912
Class I	136	61	763	15	66	76	2	0	332	1,449
Class II	251	65	1037	13	104	235	8	7	1273	2,993
Class III	181	69	1014	19	133	407	37	12	846	2,718
Class IV	237	75	391	3	133	368	119	5	573	1,904
Class V	0	0	0	0	44	0	0	0	0	44
Class VI	249	103	115	0	16	175	39	0	205	902
Class VII	91	77	28	0	10	2	8	0	70	287
Class VIII	6	15	2	0	1	0	0	0	0	24
TOTAL	1,744	569	4,151	164	784	1,557	423	37	5,803	15,233

4.3.3 Agricultural Areas and Crops Particularly Affected by Urbanization

The California agricultural areas most affected by urbanization between now and 2050 will not necessarily be those with the greatest overall amount of new urban and suburban development. Rather, other factors will come into play. These include the amount of agricultural base remaining within the region, the extent to which urban development fragments agricultural landscapes, and the extent to which farmers benefit from increased access to urban markets.

If there is relatively little agricultural base left, as is currently the case around some of the state's large metropolitan areas, then it becomes more difficult for farmers to find suppliers, processors, and other agricultural support functions (Wu et al., in press). This may affect farm operations on a crop-by-crop basis. For example, there is only one processor of apples left in Sonoma County, formerly home to extensive apple orchards, and if that facility closes, then production of classic varieties such as Gravensteins will become difficult (McKinley 2011).

If urban development fragments agricultural land into isolated pockets separated by roads, subdivisions, office parks, and other urban facilities, then it becomes more difficult for farmers to move equipment from field to field, and conflicts may arise with new suburban residents over noise, odor, and potential spraydrift associated with farming operations. Fragmentation may also reduce the benefits farmers receive from being part of a large farming community, such as sourcing inputs, accessing information, sharing equipment, and supporting processing and shipping operations (Porter 1998). Impacts on agriculture from urbanization will then be disproportionate to the land area covered.

On the other hand, urbanization can benefit agriculture if it increases access to markets (Wu et al., in press). This factor is likely to benefit some types of agriculture more than others. Specialty production of fruits, vegetables, meats, and dairy products for use by restaurants, distribution through high-end grocery stores, and sale at farmers' markets and through community-supported agriculture networks is likely to benefit. Conversely, production of grains and lower-value fruits and vegetables is not likely to see a boost from the presence of local markets, since farmers primarily sell these bulk commodities to large-scale processing facilities for regional, national, or international distribution (Ellsworth 2011).

Analysis of the spatial layout of future urbanization by 2050 within the BAU and SG scenarios shows that several current California agricultural regions are likely to be particularly affected. These include the following:

- The Highway 99 corridor in the Central Valley from Sacramento to Merced and Madera to Tulare (Figure 4.4). Both BAU and SG model runs show the most rapid growth occurring in the northern portion of this San Joaquin Valley corridor, with rapid growth also around Fresno, Visalia, and (further west) Coalinga. These areas are currently intensively farmed; the portion of the corridor most at risk of urbanization includes 5 of the 10 top agricultural counties in the state (USDA 2011). Especially under the BAU scenario, urbanization is projected to be nearly continuous between Sacramento and Merced. Major crops in areas such as San Joaquin County along the northern portion of Highway 99 (by dollar value) include milk, grapes, walnuts, cherries, almonds,

tomatoes, cattle, hay, apples, and corn (San Joaquin County Agricultural Commissioner 2011); while major crops in areas such as Fresno County further south include grapes, almonds, tomatoes, poultry, milk, cattle, garlic, pistachios, oranges, and cotton (Fresno County Department of Agriculture 2011). Fresno County is the state's top agricultural county (USDA 2011), producing \$5.94 billion worth of agricultural produce in 2010.

- The San Benito and Salinas Valleys south of the San Francisco Bay Area. Urbanization already is occurring in these areas, but is projected to accelerate, especially around Gilroy, Morgan Hill, Salinas, and Hollister. Santa Clara County, whose top crops include nursery crops, mushrooms, bell peppers, cut flowers, cattle, wine grapes, lettuce, onions, tomatoes, and cherries (Santa Clara County Department of Agriculture 2005), is likely to be especially hard hit. Monterey County, the third-ranking California agricultural county (CDFA 2010) whose top crops include strawberries, lettuce, nursery crops, broccoli, grapes, celery, and spinach (Monterey County 2010), is likely to suffer loss of agricultural land particularly around Prunedale, Salinas, and the Carmel Valley.
- Eastern Alameda and Contra Costa counties (Figure 4.5). Urbanization is projected to cover much of the remaining agricultural land in the Livermore Valley, currently predominantly grazing land on the north side and wine grapes on the south. Contra Costa County, with about double the agricultural production of its neighbor to the south, is projected to lose much farmland south, east, and west of Brentwood. The county's top 2010 crops were cattle, corn, tomatoes, grapes, cherries, alfalfa, beans, and walnuts (Contra Costa County Department of Agriculture 2011).
- Areas north of Sacramento such as Yuba City, Red Bluff, and Redding (Figure 4.6). The most significant loss of agricultural land according to UPlan model projections will occur around the Yuba City/Marysville area, approximately 40 miles north of Sacramento. Yuba County's leading crops in 2010 were rice, walnuts, prunes, peaches, milk, cattle, pasture, kiwis, timber, and almonds (Yuba County Department of Agriculture 2011).
- Ventura County north of Los Angeles. The eighth-largest California agricultural county in terms of crop value (CDFA 2010), Ventura County produces strawberries, nursery stock, lemons, celery, tomatoes, raspberries, avocados, cut flowers, peppers, and oranges (Ventura County Agricultural Commissioner 2008). UPlan 2050 growth scenarios show urbanization covering extensive portions of the county around Oxnard, Camarillo, Santa Paula, Fillmore, and Ojai. But it should be noted that the "Save Open Space and Agricultural Resources" initiatives in Ventura County are intended to reduce urban sprawl, promote sustainable communities, and protect agricultural lands (SOAR 2011).
- Multiple areas east and south of Los Angeles (Figure 4.7). These areas around Lancaster, Palmdale, Adelanto, Palm Desert, Coachella, Temecula, and Escondido have relatively modest agricultural production, and include land that is desert or mountainous. But the sheer amount of land projected to be urbanized in these locations are large, as are the presence of extensive Class I and II soils means that potential agricultural impacts.

Products are varied. San Bernardino County, for example, produces milk, eggs, cattle, alfalfa, bok choy, oranges, trees and shrubs, indoor decoratives, and ground covers (County of San Bernardino 2010). The Agricultural Commissioner in this county notes that production, especially of dairy (the leading product), is already declining due to problems with water, regulation, a decrease in local support services, and a shrinking number of producers (Ibid, p. 2).

Urban growth as modeled by Uplan for business as usual and smart growth scenarios
(Fresno-Bakersfield)

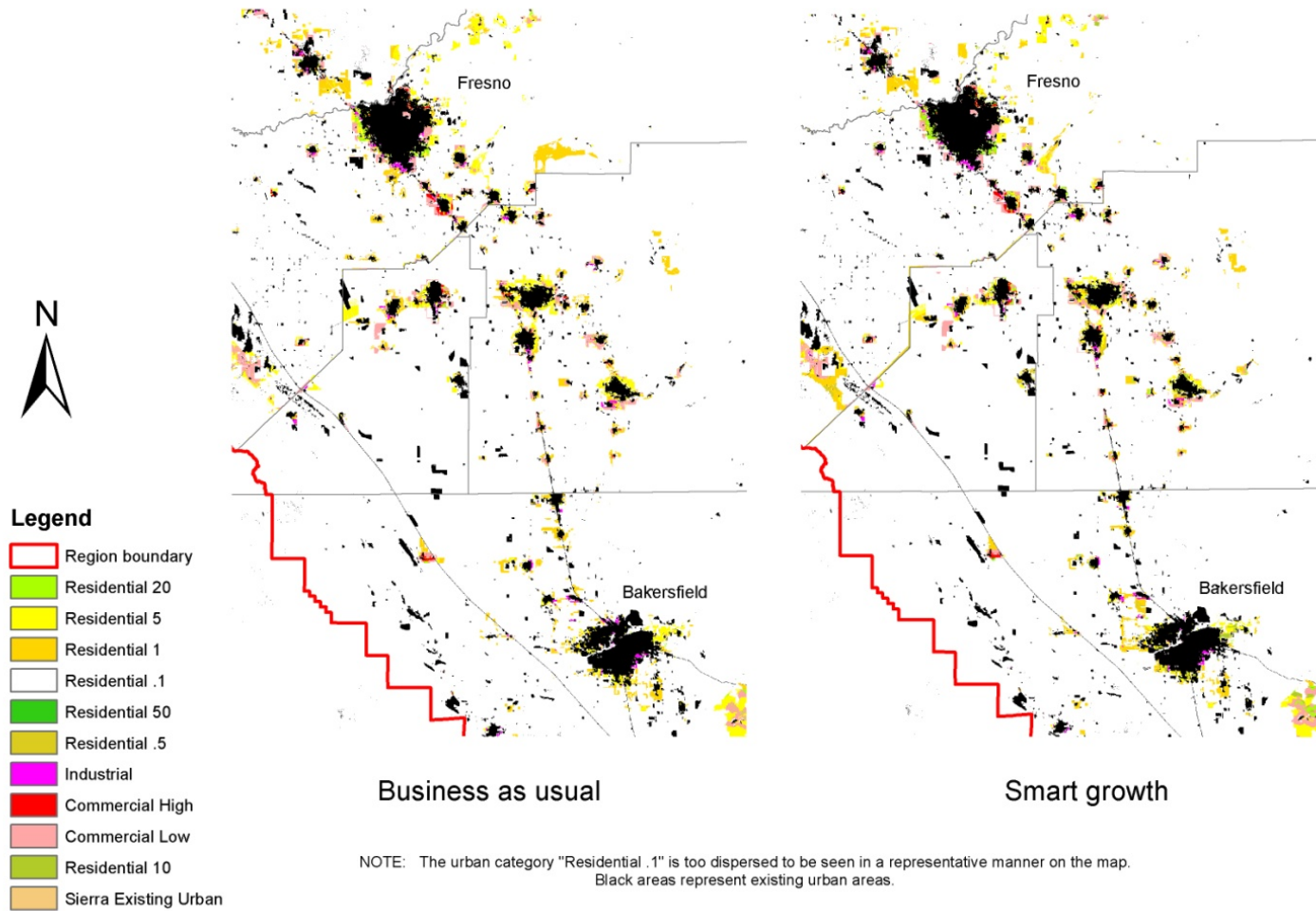

Figure 4.4. 2050 Urban Growth Detail Map for the Lower San Joaquin Valley, BAU, and SG Scenarios

Urban growth as modeled by Uplan for business as usual and smart growth scenarios
(Bay Area)

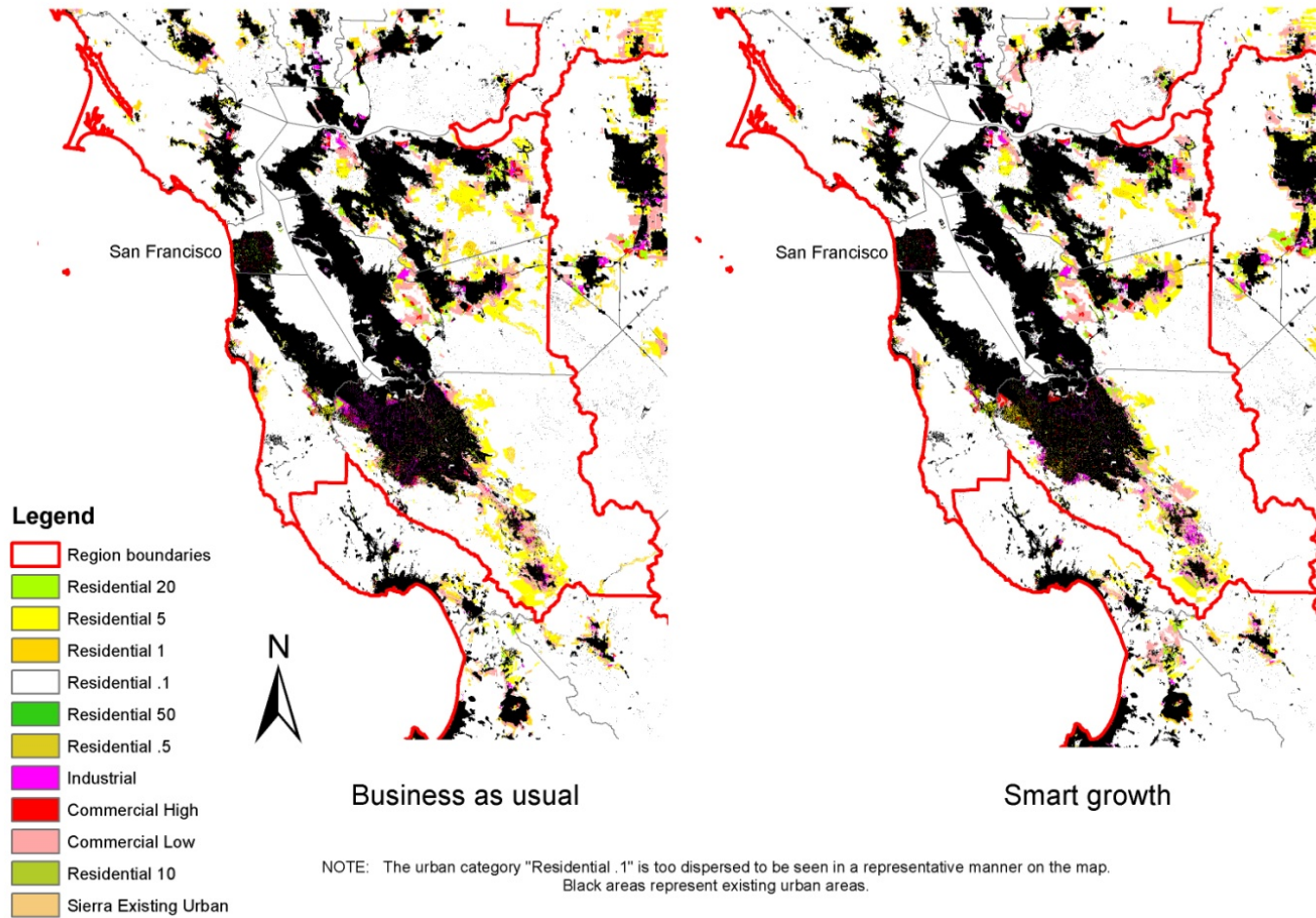

Figure 4.5. Urban Growth Detail Map for the Bay Area, BAU, and SG Scenarios

Urban growth as modeled by Uplan for business as usual and smart growth scenarios
(Sacramento-Stockton)

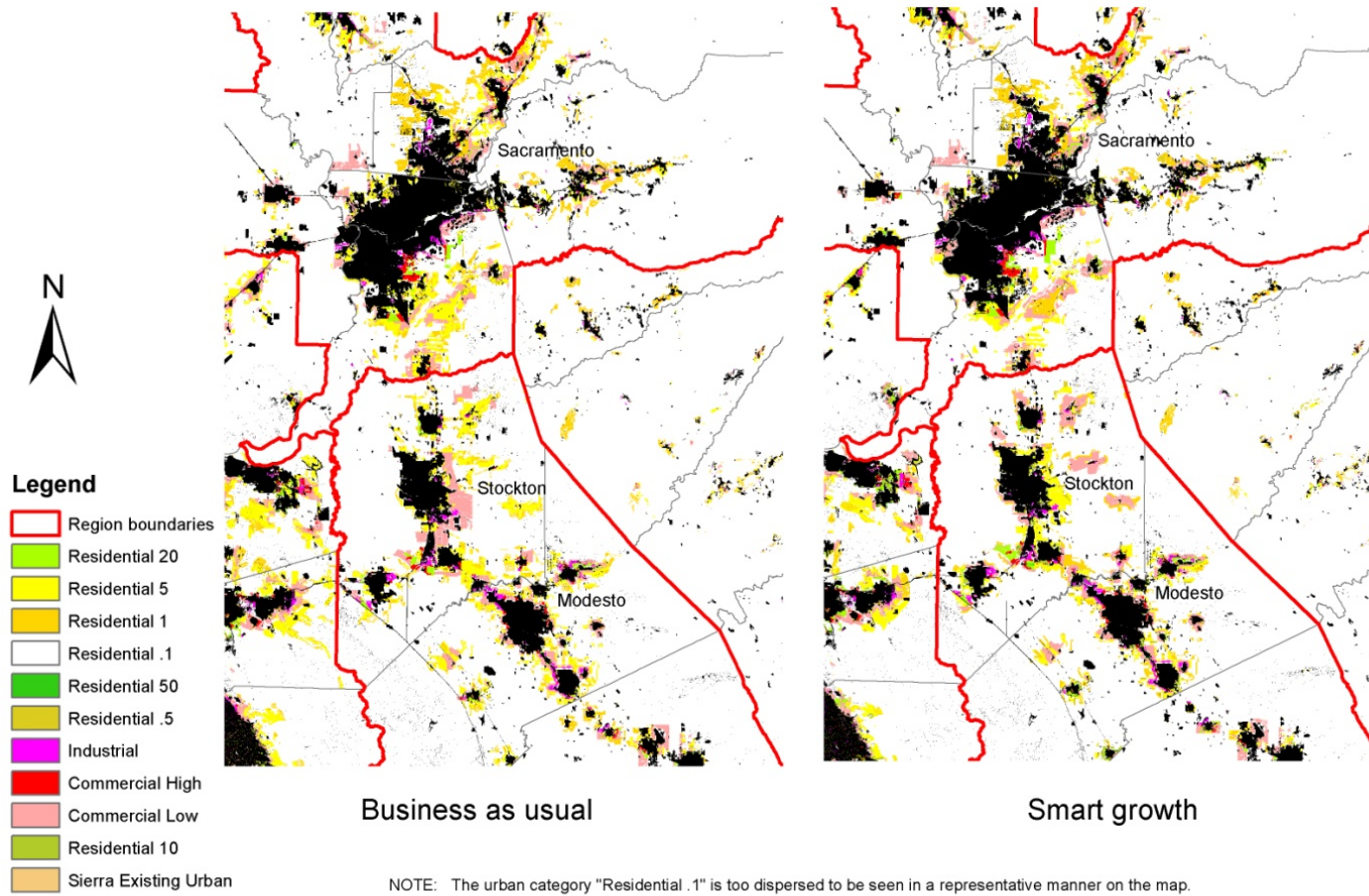

Figure 4.6. 2050 Urban Growth Detail Map for the Sacramento Area, BAU, and SG Scenarios

Urban growth as modeled by Uplan for business as usual and smart growth scenarios
(Southern California)

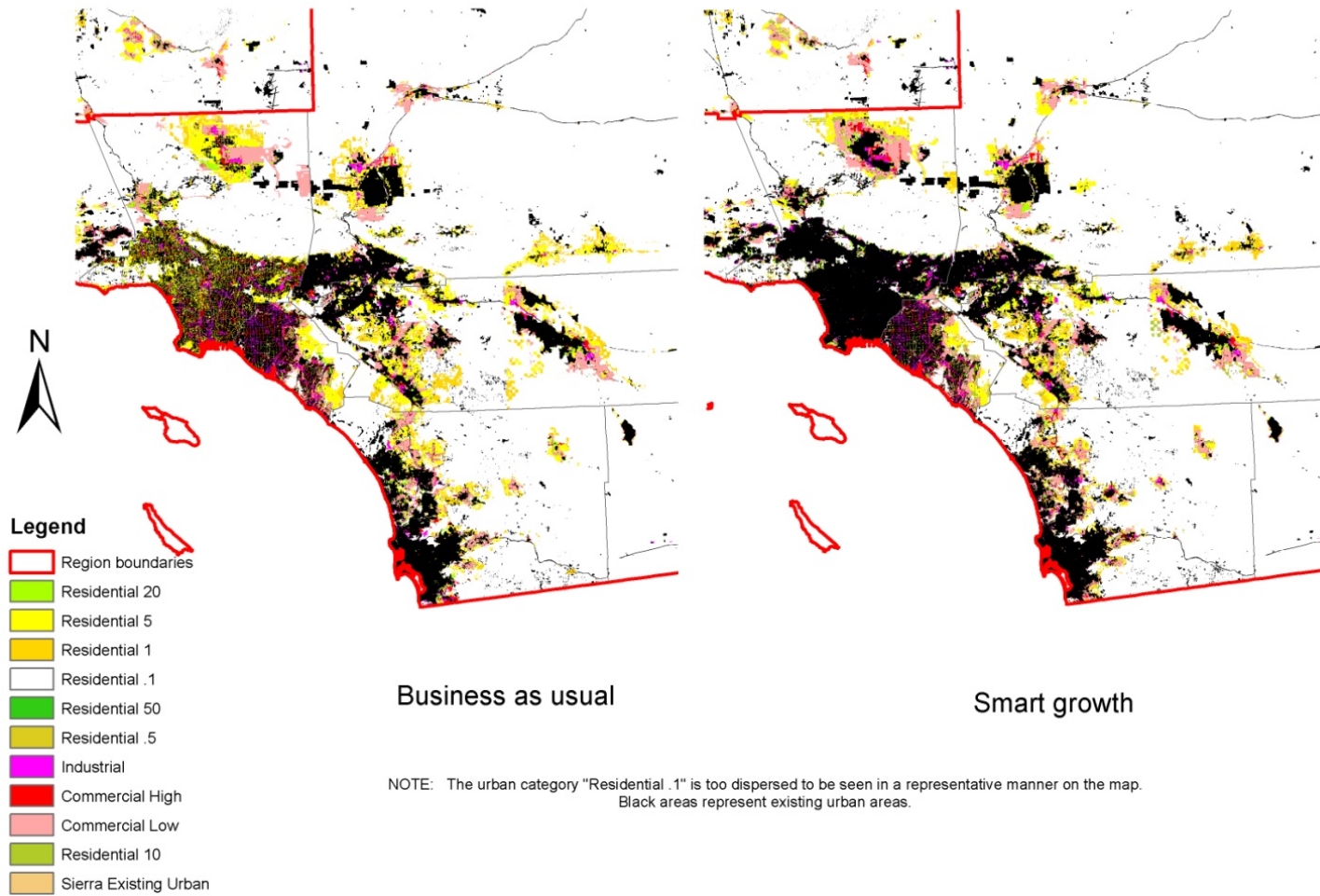

Figure 4.7. Urban Growth Detail Map for Southern California, BAU, and SG Scenarios

4.3.4 Implications of the Yolo County Example for Statewide Agriculture-Urbanization-Climate Change Analysis

Our current and previous analysis of agricultural landscape and climate change in Yolo County (Jackson et al. 2012) yields a number of findings that are relevant to analysis of urbanization and agricultural landscapes statewide. This analysis included UPlan modeling of three 2050 urban growth scenarios for Yolo County, one similar to the BAU alternative here, one similar to the SG alternative here, and one that focused entirely on infill development (going beyond the Infill Scenario under development by ICE). Because Yolo County has a strong history of protection of agricultural lands and relatively strong planning frameworks to increase density within urban areas, we assumed somewhat higher urban densities for all scenarios than did ICE for the statewide modeling. Thus, impacts on agriculture were somewhat lower than can be expected for urbanization statewide.

Particular findings from the Yolo County analysis that may prove relevant to statewide agricultural landscapes include the following:

- Urbanization on agricultural land was 113 percent higher in the Yolo County A2 (BAU) scenario than in the B1 (SG) alternative. In other words, moderate smart growth policies were relatively effective at reducing the impacts of urbanization on agricultural land.
- By 2050 in the A2 (BAU) scenario, low-density residential and commercial land uses consumed by far the most agricultural land (90 percent of all farmland consumed by development). To put it another way, low-density urban development (such as ranchettes, large-lot rural estates, auto malls, and big-box stores) results in far higher reductions in agricultural land per residents or workers served than moderate or high urban densities, and policy interventions to reduce these particular development forms may carry benefits for California agriculture.
- New urban development in the A2 (BAU) scenario was relatively fragmented, meaning that subdivisions were sprinkled across agricultural land, likely undermining the viability of surrounding agricultural operations. Policies to reduce fragmentation of agricultural land may likewise be desirable.
- Holding demographic and technological variables constant, transportation-related GHG emissions were 23 percent less when new urban development occurred in the B1 (SG) pattern (i.e., less on agricultural land and more within denser infill locations) as opposed to the A2 (BAU) scenario. Transportation-related GHG emissions in the AB 32+ (Infill) scenario were 53 percent less. Residential energy use was also lower for these alternative scenarios (due primarily to smaller housing unit sizes and multifamily building construction), 18 percent and 33 percent, respectively. Thus, smart growth policies are likely to help the state achieve GHG mitigation goals in addition to preserving agricultural land.

4.5 Potential Policy Interventions

Land use planning in California is inherently a political subject (Fulton and Shigley 2005), and depending on state, regional, and local political dynamics, including the adoption and implementation of climate change policy, may result in a number of different mechanisms being employed to manage urban growth. In Table 4.5, we note a number of the land use policy strategies that might be employed between now and 2050, and briefly comment on their potential implications for agricultural landscapes in the context of climate change.

4.6 Conclusion

In the 2050 time frame, urbanization is likely to have significant effects on California agriculture, covering as much as 10 percent of total agricultural landscapes and 19 percent of Class I and II soils. Largest effects are likely to occur in the Central Valley, especially the Sacramento Region and San Joaquin Valley. However, agricultural lands in the Bay Area, Monterey/Salinas area, and Ventura County will see major impacts as well.

Such loss of farmland by itself is likely to reduce agricultural production. However, climate change will also pose significant challenges to farmers during this time period, potentially leading to a greater cumulative loss of production.

A number of interventions could reduce loss of farmland to urban development during the coming decades. Many of these policy frameworks (e.g., zoning, the Williamson Act, Urban Growth Boundaries) are already relatively well known. Others (e.g., conservation easements, transfer of development rights, preferential fees for infill development, regional Blueprint planning) are newer or less known. The SG scenario discussed here and the B1 and AB 32+ scenarios for Yolo County mentioned here and presented separately show that such strategies could minimize loss of farmland, as well as reducing GHG emissions, compared to the BAU scenario.

Table 4.5. Potential Policy Interventions to Manage Urbanization So as to Reduce Agricultural Vulnerability in the Context of Climate Change

Policy Intervention	Discussion/Implications
1. Zoning for agricultural use or large minimum parcel sizes (unsuited to residential or commercial development).	The main mechanism California local governments currently use to protect agricultural land. Relatively weak (land can be rezoned by a majority vote of the local governing body). Large parcel sizes may make organic agriculture and diversified practices difficult.
2. Williamson Act. (Lowers property taxes for farmers pledging not to develop land for 10 years.)	Another main current mechanism. Not a long-term agricultural preservation strategy, since landowners can withdraw from the program when contracts expire. State funding is highly uncertain.
3. Agricultural Conservation Easements. (Nonprofit organization or public agency purchases an easement precluding development on farmland. Sometimes known as “purchase of development rights.”)	A popular, long-term strategy to preserve farmland near urban areas. Requires that sufficient funds be available and organizations be able to conduct long-term monitoring. Limited by availability of funding and nonprofit interest.
4. Urban Growth Boundaries (UGBs). (Local government by public vote or council action establishes a boundary beyond which agricultural land is preserved, usually by preventing subdivision of land.)	Adopted by at least 17 Bay Area cities as well as Contra Costa County. A relatively long-term measure. By ensuring that urban development is contiguous, can help reduce the fragmentation of agricultural land by encroaching urbanization, thus improving agricultural viability on the urban fringe. Best if coordinated regionally.
5. Urban Service Boundaries. (Local governments limit extension of water, sewer, roads, and other public services, thus making development difficult.)	Used historically by cities such as San Jose. Weaker than UGBs (more open to political override), but often effective, and can be combined with other mechanisms. Risk of allowing large-lot development on septic systems to proceed.
6. Differential Impact Fees. (Local jurisdictions charge higher per-unit fees for development on agricultural land than on infill sites.)	Used historically in Lancaster, California, as well as in non-California cities such as Albuquerque. Can provide a strong economic incentive for infill and disincentive for urbanization of farmland. Also helps reflect true local government costs of servicing far-flung development. May require coordination between local jurisdictions.
7. Regional Blueprint Planning. (Metropolitan Planning Organizations (MPOs) develop an overall growth vision through extensive public process.)	Done to date in the Sacramento region, and under different names in the Bay Area, Los Angeles area, and San Diego region. Can dovetail well with the Sustainable Communities Strategies required by SB 375. Can potentially help coordinate regional open space and agricultural planning with urbanization and climate change planning. Regional visions tend to rely on local implementation through measures such as those listed above.

4.7 References

- Beardsley, K. et al. 2009. "Assessing the influence of rapid urban growth and regional policies on biological resources." *Landscape and Urban Planning* 93(2009): 172–183.
- Bedsworth, L., E. Hanak, and J. D. Kolko. 2011. *Driving Change: Reducing Vehicle Miles Traveled in California*. San Francisco: Public Policy Institute of California.
- Byrd, K. B., A. R. Rissman, and A. M. Merenlander. 2009. "Impacts of Conservation easements for threat abatement and fire management in a rural oak woodland landscape." *Landscape and Urban Planning* 92(2): 106–116.
- CAGO. 2009. Climate Change, the California Environmental Quality Act, and General Plan Updates: Straightforward Answers to Some Frequently Asked Questions. California Attorney General's Office, Sacramento, California.
- California Department of Food and Agriculture (CDFA). 2010. *California Agricultural Resource Directory 2010–2011*. Sacramento. Available at <http://www.cdfa.ca.gov/statistics/>; accessed September 7, 2011.
- Contra Costa County Department of Agriculture. 2011. *2010 Annual Crop and Livestock Report for Contra Costa County*. Concord. Available at <http://www.co.contra-costa.ca.us/DocumentView.aspx?DID=6042>; accessed September 6, 2011.
- County of San Bernardino. 2010. Crop and Livestock Report 2009.
- Ellsworth, S. 2011. Growing at the Urban Edge: Enhancing Ecosystem Services Through Community Farms in Davis, CA. Masters Thesis. University of California, Davis, Community Development Graduate Group.
- Fresno County Department of Agriculture. 2011. *Fresno County 2010 Annual Crop and Livestock Report*. Fresno. Available at <http://www.co.fresno.ca.us/Departments.aspx?id=114>; accessed September 9, 2011.
- Fulton, W., and P. Shigley. 2005. *Guide to California Planning*. Point Arena, California: Solano Press Books.
- Greenbelt Alliance. 2008. *Smart Infill*. San Francisco. Available at <http://www.greenbelt.org/resources/reports/smartinfill/index.html>; accessed September 13, 2011.
- Hollander, A. D. 2007. California Augmented Multi-purpose Land-cover (CAML) Dataset. <http://cain.ice.ucdavis.edu/caml/camlmeta.html>.
- Johnston, R. A., D. R. Shabazian, and S. Gao. 2004. "UPlan: A Versatile Urban Growth Model for Transportation Planning." *Transportation Research Record* 1831:202–209

- McKinley, Jesse. 2011. "Gravenstein Apples Struggle to Survive in Sonoma County." *The New York Times*. September 1. Available at <http://www.nytimes.com/2011/09/02/us/02apples.html>; accessed 9/6/11.
- Merenlender, A. M., C. Brooks, D. Shabazian, S. Gao, and R. A. Johnston. 2005. *Forecasting exurban development to evaluate the influence of land-use policies on wildland and farmland conservation*. Institute of Transportation Studies, University of California, Davis, Research Report UCD-ITS-RR-05-33.
- Monterey County Agricultural Commissioner's Office. 2010. Monterey County Crop Report 2009. Salinas. Available at: <http://ag.co.monterey.ca.us/assets/resources/assets/18/CropReport2009.pdf?1296154928>; accessed 9/6/11.
- Porter, Michael E. 1998. "Clusters and the New Economics of Competition." *Harvard Business Review* 76 (6): 77–90.
- Sacramento Metropolitan Air Quality Management District (SMAQMD). 2011. *CEQA Guide to Air Quality Assessment*. Sacramento. 6–4.
- San Joaquin County Agricultural Commissioner's Office. 2011. *2010 Annual Crop Report*. Stockton. 12. Available at <http://www.sjgov.org/agcomm/annualrpts.aspx>; accessed September 6, 2011.
- Santa Clara County Department of Agriculture. 2005. *Santa Clara County Agricultural Crop Report 2005*. San Jose. Available at [http://www.sccgov.org/SCC/docs%2FAgriculture,%20Division%20of%20\(DIV\)%2Fattachments%2FCropReport2005.pdf](http://www.sccgov.org/SCC/docs%2FAgriculture,%20Division%20of%20(DIV)%2Fattachments%2FCropReport2005.pdf); accessed September 6, 2011.
- SOAR (Save Open Space and Agricultural Resources). 2011. News and Views Newsletter. <http://www.soarusa.org/newsletters.html>.
- Soil Survey Staff. 2006. *Keys to Soil Taxonomy*, 10th ed. USDA-Natural Resources Conservation Service, Washington, D.C.
- Thomas, J. V. 2009. *Residential Construction Trends in America's Metropolitan Regions*. Washington, D.C.: U.S. Environmental Protection Agency. Available at <http://www.greenbelt.org/resources/reports/smartinfill/index.html>; accessed September 13, 2011.
- Thorne, J., J. Bjorkman, and N. Roth. 2012. *Urban Growth in California: Projecting Growth in California (2000–2050) Under Six Alternative Policy Scenarios and Assessing Impacts to Future Dispersal Corridors, Fire Threats and Climate-Sensitive Agriculture*. California Energy Commission. Publication number: CEC-500-2012-009.
- USDA Economic Research Service. 2011. "State Fact Sheets: California." Available at <http://www.ers.usda.gov/statefacts/ca.htm#TCEC>; accessed September 6, 2011.

- Ventura County Agricultural Commissioner. 2008. *Ventura County Crop Report 2007*. Santa Paula. Available at http://ucanr.org/sites/Farm_Management/files/108664.pdf. Accessed September 7, 2011.
- Wohletz, L. R., and E. F. Dolder. 1952. *Know California's Land: A Land-Capability Guide for Soil and Water Conservation in California*. Sacramento: State of California Department of Natural Resources and Soil Conservation Service, USDA.
- Wu, J., M. Fisher, and U. Pascual. In press. Urbanization and the viability of local agricultural economies. *Land Economics*.
- Yuba County Department of Agriculture. 2011. *2010 Crop Report for Yuba County*. Marysville. Available at: http://www.co.yuba.ca.us/departments/Ag/documents/Crop_Reports/2010_CropReport.pdf.

5.0 Carbon Stocks and Land Use in a Vineyard/Woodland Landscape: A Case Study of Fetzer Vineyards

J. Williams, A. Hollander, A. O'Geen, A. Thrupp, K. Steenwerth, G. McGourty, and L. E. Jackson

5.1 Introduction: Carbon Assessment on Vineyard/Woodland Lands

Addressing climate change is a priority issue for Californians and involves individuals, businesses, and government. The Global Warming Solutions Act of 2006 (AB 32) seeks to reduce the emission of greenhouse gases (GHG) to 1990 levels by 2020. This legislation goes into effect gradually, so that people will have time to implement the necessary actions to come into compliance by the 2020 deadline. Some businesses, however, are proactive on climate change mitigation, and are signing up through mechanisms such as the Climate Action Registry to become leaders and early adopters of GHG emission-reduction programs. By making progress toward carbon neutrality (where carbon equivalent emissions are balanced by carbon sequestration, such as reforestation projects, and by reduction in other types of GHG emissions) ahead of deadlines, these companies may qualify for incentive programs and be recognized as environmental leaders.

Among such leaders are a number of wine companies that are managing their vineyard lands and adjoining forests that maximize biomass on the landscape and balance the emissions generated in their production processes. This paper is a case study about one such company, Fetzer/Bonterra Vineyards, who has set their objectives to reduce their GHG emissions and use renewable sources to meet much of its energy demands. As an environmentally conscious business, and a major grower and producer of wines, Fetzer/Bonterra attempts to achieve a balance between habitat conservation, ecologically based organic production, production goals, and financial profit. When the company purchased ranches for growing grapes in Mendocino County, a decision was made to maintain a large fraction of that land in natural habitat without livestock grazing. This was based on an environmental ethic to combine wine production with conservation of the landscape's natural integrity. This approach also included a series of sustainability measures (e.g., third-party certification, solar power generation, reduced packaging, GHG emission reductions through fleet fuel efficiency).

To learn more about the carbon storage and dynamics on its land, Fetzer/Bonterra collaborated with researchers at the University of California Davis to conduct an assessment of the distribution and magnitude of carbon stored across the vineyard-woodland landscape. The main goal was to find a way to assess carbon stocks to determine the absolute and relative amounts of carbon stored in different vegetation and land use types. Fetzer/Bonterra's rationale behind the assessment was to identify the relative value of the different vegetation types on their land in terms of contributing to the positive, or offset, side of their carbon budget. Because the study also collected data on the different woody plant species, information on the diversity of plant communities was obtained. The species and community diversity data make it possible to assess the relationship between carbon (C) stocks and biodiversity, and to show how habitat type affects the magnitude of C stocks. This approach will allow vineyard managers to prioritize non-vineyard land for carbon

storage, biodiversity and habitat conservation, and eventually other types of ecosystem services, such as keeping steep slopes and stream corridors forested to protect against erosion and sediment loading in waterways. Greater carbon stocks in forests is to be expected, but it is significant to recognize that Fetzer/Bonterra uses a management approach for a combination of perennial woody crops and conserved habitat that maximizes the contribution of the heterogeneous landscape to total carbon stocks.

Using this Fetzer/Bonterra case study experience as an example, this paper showcases the important role that California agricultural landscapes can play in climate change adaptation and mitigation strategies. With a special emphasis on vineyards, which have higher wood C stocks than annual cropping systems, the paper considers the relative contributions of different land use regimes in contributing to carbon storage. (Details are given in Williams et al., in press). Following an explanation of field methods, data analysis, and research findings, we examine some of the opportunities and limitations facing growers in the current policy climate for maintaining or increasing carbon stocks. A discussion then considers how policies and incentives could be amended to encourage greater participation in activities that promote the management of agricultural land as a multifunctional landscape—that is, a landscape in which production is only one of the valued outputs alongside carbon sequestration, soil quality, biodiversity protection, and other ecosystem services.

5.2 Overview of the Fetzer/Bonterra Vineyard Study on Carbon Stocks

The assessment of carbon stocks for Fetzer/Bonterra Vineyards was conducted on five ranches scattered across the Russian River valley near the town of Hopland in Mendocino County, California (Figure 5.1). Fetzer grows organic grapes for its Bonterra label on these ranches, which vary in topography, size, area under cultivation, and the number of different habitat types present. In total, the ranches comprise about 1,150 hectares (2,800 acres) of land, roughly 30 percent of which is in vine cultivation, 35 percent in forested land, and most of the remainder in grassland.

The non-cultivated habitat of the study area varied from oak woodland and mixed hardwood forests, to chaparral and grasslands in drier sites, as well as a distinct riparian vegetation surrounding waterways. Most of the non-vineyard, non-riparian forested land was mixed hardwood forest, dominated by a variety of oak species (*Quercus spp.*) and interspersed with madrone (*Arbutus menziesii*), bay (*Umbellularia californica*), buckeye (*Aesculus californica*), and the occasional Douglas fir (*Pseudotsuga menziesii*). Several woody shrub species were found in the understory of the forestlands, including manzanita (*Arctostaphylos spp.*), ceonothus (*Ceanothus spp.*), and toyon (*Heteromeles arbutifolia*), at times forming pure stands of chaparral shrubs where soils and exposure presented the ideal conditions. The riparian areas were characterized by a different suite of hardwood species, including maples (*Acer spp.*), alders (*Alnus rhombifolia*), cottonwoods (*Populus spp.*), ash (*Fraxinus latifolia*), and willows (*Salix spp.*). In total, 29 woody species were recorded on the five ranches.

In vineyard tracts, carbon was estimated for only the aboveground woody portion of the vines, which are grown as a monoculture, planted in parallel rows that were also approximately two meters apart. Using a sampling regime based on a geographic information system (GIS), carbon was measured in soil from 44 pits that were 1 meter (m) deep, and in aboveground woody

biomass, from 93 vegetation plots. The sampling points were located according to a representative set of sites on each of seven different habitat types. To estimate the carbon stored in a given tract, the average biomass per vine, calculated using allometric equations⁴ developed with age and main stem diameter, was multiplied by the number of vines in each tract (provided by the grower). Similarly, field measurements combined with published allometric equations for native woody species were used to estimate woody biomass for the non-vine species sampled on 10 x 30 m plots in forestlands. Soil carbon was estimated after combustion analysis of samples taken from the soil pits that were located in forested and vineyard lands.

The data for the vegetation samples were integrated into a GIS together with remotely sensed imagery using a cluster analysis technique to produce a general landcover classification map with seven categories. The amount of carbon stored on a given hectare of land was thus estimated to be a function of its habitat classification and the carbon values for the samples in that category (Figure 5.2). Soil carbon was estimated in a similar way, but samples were compared to existing soil maps from the national Soil Survey Geographic Database (SSURGO). These distribution maps, along with the sampled carbon values, were used to extrapolate carbon across the landscape to give both per hectare estimates of carbon stocks and total carbon estimates per ranch.

The results of the study show two main conclusions with respect to carbon stocks (Table 5.1): (1) that per hectare, the top meter of soil holds substantially more carbon than the aboveground woody vegetation, ranging from 5 times more in forests to 50 times more in vineyards, on average; and (2) forestlands store more carbon in both soil and aboveground woody vegetation than vineyards. On average, forested wildlands had 45 percent more total C/hectare than vineyards. That is, there are approximately 12 times more aboveground woody carbon and 6 percent more soil carbon per unit area in wildlands than in vineyards.

Among wildland vegetation types, valley riparian habitats had the highest carbon stocks, and most of the carbon came from soil (Williams et al., in press). This is most likely due to long-term upland erosion, and subsequent deposition of organic material along the floodplains (Naiman and Decamps 1997) of the Russian River and its tributaries. The upland vegetation types had more variability in soil carbon stocks, but closed-canopy mixed hardwood forest (e.g., the Butler and Hooper ranches) made the greatest contribution to C stocks (Figure 5.2). For vineyard tracts, the age of the vines explained much of the variation in aboveground C stocks and wood biomass. But even the largest vines contained only about one-fourth of the wood biomass per hectare of the adjacent wooded wildlands.

⁴ Allometric equations relate some characteristic of vegetation that is easy to measure, such as trunk diameter, to another characteristic that is more difficult to measure, in this case wood volume, by establishing a statistical relationship between those characteristics as measured on a sample of individuals of different sizes and/or ages.

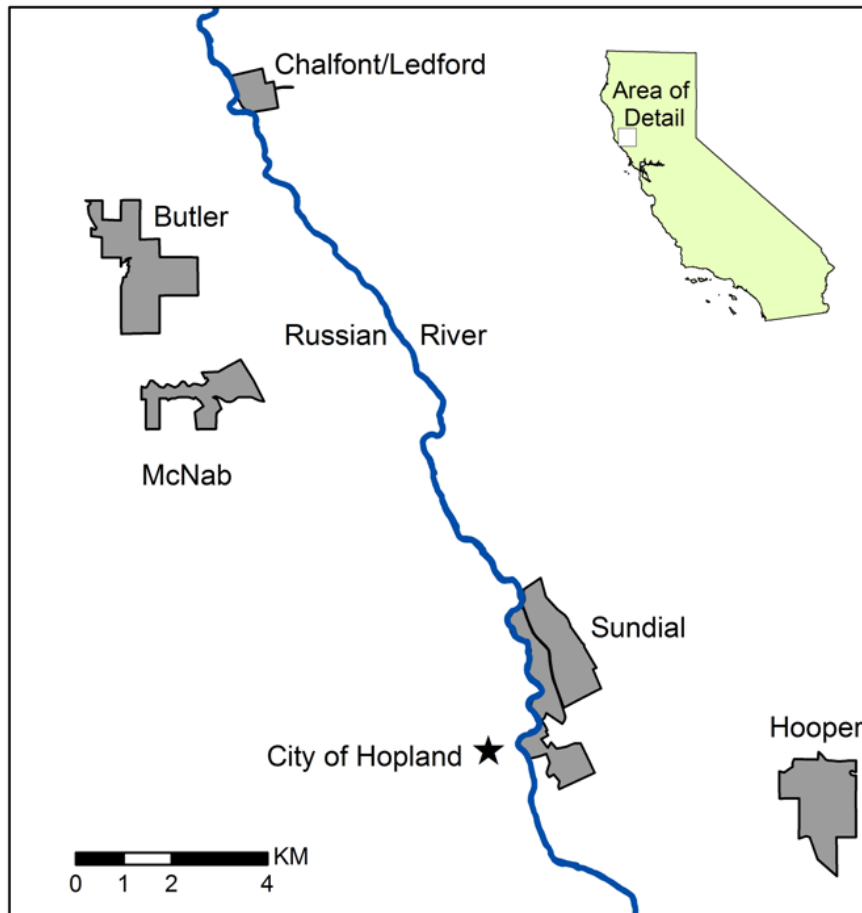

Figure 5.1. Study Site in Mendocino County, California (state shown in inset), with the Location of the Five Wine Grape-growing Ranches (labeled) Where Carbon Stocks Were Assessed for Vineyards and Adjoining Wildlands

Under Fetzer/Bonterra’s organic management, vineyards stored fairly high levels of soil organic carbon (SOC) (1 to 2 percent C in the top 0–15 centimeters [cm] of soil) by temperate conventional cropping standards (VandenBygaart et al. 2010; van Groenigen et al. 2011). Management of these vineyards places a high priority on soil quality. A survey using a simple scoring system was completed by the vineyard managers on the historical management of each vineyard block, detailing such practices as tillage schedule, use of compost, or cover crop mix over the past five years (Williams et al., in press). No detectable effects of number of types of management practices were found on carbon content of the top 15 cm of soil, which is the soil layer where management practices are most likely to have an effect. This was probably because the overall strategy was to manage each block to accumulate organic matter, resulting in little difference in soil carbon among blocks.

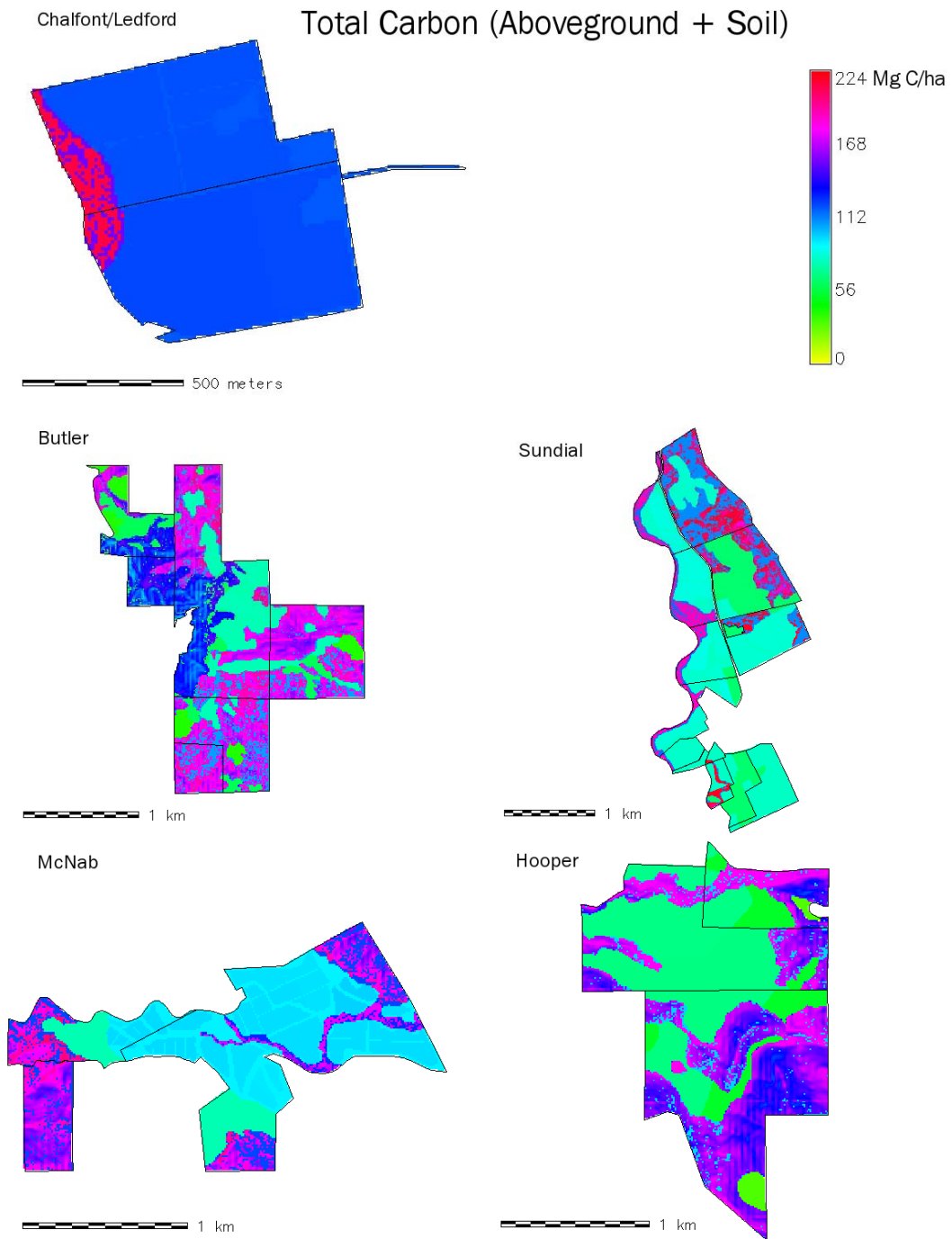

Figure 5.2. Spatial Representation of Total Carbon Stocks in Aboveground Wood and Soil (to 1 m depth) for the Five Ranches Considered in this Study

Table 5.1. Per Hectare and per Ranch Results of Carbon Assessment Shown by Land Use Type (vineyard or wildlands) and by Carbon Reservoir Considered (i.e., Aboveground (AG) or Soil). For more detail, see Williams et al., in press).

Ranch	Vineyards			Wildlands		
	Soil Mg C/ha	AG-Wood Mg C/ha	Total Mg C/ha	Soil Mg C/ha	AG-Wood Mg C/ha	Total Mg C/ha
Chalfont/ Ledford	118.7	3.6	122.3	132.7	14.0	146.6
Butler	76.0	2.3	78.3	87.6	47.6	135.2
McNab	92.3	4.5	96.8	106.8	19.2	125.9
Sundial	80.0	4.1	84.1	91.8	22.8	114.7
Hooper	68.0	0.7	68.7	83.8	34.3	118.1
Average	84.1	3.0	87.1	89.3	36.8	126.1
Std Dev	6.6	0.48	7.0	14.5	8.6	22.9

5.3 Implications and Future Directions

Planning ahead for climate change in agricultural landscapes involves more than crop management for reducing GHG emissions and coping with uncertain temperatures and precipitation (Smith and Olesen 2010). Land managers must have the capacity to respond to unforeseen change in natural resources as well. Integration of forest, other natural habitat and vegetation types, and agricultural ecosystems into complex landscapes is increasingly viewed as a way to increase the provision of multiple ecosystem services, including carbon storage, pest management, nutrient retention, erosion control, and water quality (Tscharntke et al. 2005; Gordon et al. 2010). Complex landscapes that are rich in biodiversity help to “keep options open” for alternative future management, even if such a strategy appears inefficient and suboptimal in the present tense (Jackson et al. 2010).

In a mosaic approach for vineyard management, management objectives allow topography and habitat variability to determine the amount and configuration of vine tracts and wildlands. It was the landscape variability (e.g., in slope, aspect, soil quality, or species composition) that also presented the greatest challenges to modeling carbon in this study. Combining GIS- and field-based approaches was a useful way to sample and analyze vegetation-based habitat types for their carbon stocks across the landscape (Williams et al., in press). Variability in tree species composition and distribution within habitat types, as well as the many soil types (i.e., eight soil great groups) showed the necessity of refined models to address heterogeneity for assessing C stocks. Two specific improvements would make for greater accuracy in future woody plant carbon estimates: (1) a more comprehensive set of allometric equations for extrapolating aboveground woody biomass of California tree species from field measurements such as

diameter at breast height (DBH); and (2) understanding which environmental variables best explain the variation in aboveground woody biomass and developing relevant procedures so carbon stocks can be accurately estimated on specific land holdings.

Methods for improving the estimation of carbon stocks will be necessary if regulating bodies make carbon accounting mandatory or provide incentives for maximizing C storage. At present, however, most regulation is focused on emissions, such as AB 32. The U.S. Government has also taken an emissions control approach, such as when the U.S. Environmental Protection Agency declared carbon dioxide (CO₂) and five other GHGs to be air pollutants subject to regulation in 2009. In California, viable voluntary carbon offset projects must qualify for one of three categories: reforestation; improved forest management; or avoided conversion. This means that forest cover must increase by planting or management techniques, or land owners must demonstrate that forested land is at risk for conversion, and therefore its protection meets the requirement of additionality (CAR 2011).

In California in 2006, transportation, energy production, and industry accounted for more than 80 percent of annual GHG emissions; whereas, agriculture collectively contributed only 6 percent (of which livestock made up a large percentage) (ARB 2009). At first glance, it seems that paying for carbon storage on croplands in California would have only a small effect on reducing total GHG emissions and that high transaction costs would discourage any such policy, given the thousands of farms in the state. But marginal lands, remnant natural vegetation, and restored ecosystems within agricultural landscapes could potentially account for substantial carbon benefits in California, based on the results of this study, as well as provide a host of additional environmental benefits not measured here. At present, woody plants in agricultural landscapes are not eligible for carbon offsets in California's forest protocol (CAR 2011). This situation deserves further recognition, not only to retain an important set of carbon stocks by avoided deforestation, but because incentives for managing a vineyard/wildland mosaic contribute toward other ecosystem services, such as threatened or endangered species habitat protection (e.g., stream habitat for salmon), water quality and storage capacity, soil erosion, and nutrient run-off control.

The importance of maintaining forest lands has been a major issue for scientists and policy makers concerned with global warming. Efforts to develop incentives to reduce deforestation have produced global campaigns like the United Nations REDD and REDD-plus programs (Reduce Emissions from Deforestation and Forest Degradation in developing countries), as well as specific efforts to slow deforestation in key tropical forest biomes (Blom et al. 2010). A crucial issue in the global deforestation debate is the renewed recognition for the importance of forested lands that exist in agricultural landscapes that are not formally considered forests (van Noordwijk et al. 2008; Langford 2011).

In conclusion, for complex landscapes, high resolution spatial modeling is challenging and requires accurate characterization of the landscape by vegetation type, physical structure, sufficient sampling, and allometric equations that relate tree species to the landscape. While remote sensing techniques may improve the accuracy of carbon estimation, climate change policy in California shows a lack of focus on storage compared to emissions, and on agriculture

compared to other sectors. These oversights may lead to missed opportunities for maximizing ecosystem services, including carbon storage, as well as for encouraging better farm stewardship and habitat conservation. Many types of agricultural landscapes have some fraction of their land out of production and in forests or other forms of conserved habitat. Yet this land is generally not being counted in carbon accounting protocols such as AB 32. As a result, land owners are not being recognized or rewarded for the role they are playing in storing carbon in forested lands. Furthermore, if such rewards or incentive programs did exist, it is highly likely that many producers would take an active role in reforesting parts of their land that is not in production, or planting hedgerows or other vegetation, in order to qualify for these programs.

5.4 References

- ARB. 2009. Greenhouse Gas Inventory Data - 2006–2009. California Environmental Protection Agency, Air Resources.
- Blom, B., T. C. H. Sunderland, and D. Murdiyarso. 2010. "Getting REDD to work locally: Lessons learned from integrated conservation and development project." *Environmental Science and Policy* 13:164–172.
- CAR. 2011. Forest Project Protocol, Version 3.2. Climate Action Reserve, Sacramento.
<http://www.climateactionreserve.org/how/protocols/adopted/forest/development/>.
- Gordon, L. J., C. M. Finlayson, and M. Falkenmark. 2010. "Managing water in agriculture for food production and other ecosystem services." *Agric. Water Manage.* 97:512–519.
- Jackson, L. E., M. van Noordwijk, J. Bengtsson, W. Foster, L. Lipper, M. Said, J. Snaddon, and R. Vodouhe. 2010. "Biodiversity and agricultural sustainability: From assessment to adaptive management." *Current Opinion in Environmental Sustainability* 2:80–87.
- Langford, K. 2011. Integrating agriculture and forestry in the landscape is key to REDD.
<http://www.worldagroforestrycentre.org/newsroom/press-releases/integrating-agriculture-and-forestry-landscape-key-redd>.
- Naiman, R. J., and H. Decamps. 1997. "The ecology of interfaces: Riparian zones." *Annu. Rev. Ecol. Syst.* 28:621–658.
- Smith, P., and J. E. Olesen. 2010. "Synergies between the mitigation of, and adaptation to, climate change in agriculture." *Journal of Agricultural Science* 148:543–552.
- Tscharntke, T., A. M. Klein, A. Kruess, I. Steffan-Dewenter, and C. Thies. 2005. "Landscape perspectives on agricultural intensification and biodiversity - ecosystem service management." *Ecology Letters* 8:857–874.
- van Groenigen, K. J., A. Hastings, D. Forristal, B. Roth, M. Jones, and P. Smith. 2011. "Soil C storage as affected by tillage and straw management: An assessment using field measurements and model predictions." *Agric. Ecosyst. Environ.* 140:218–225.

- VandenBygaart, A. J., E. Bremer, E., B. G. McConkey, H. H. Janzen, D. A. Angers, M. R. Carter, C. F. Drury, G. P. Lafond, and R. H. McKenzie. 2010. "Soil organic carbon stocks on longterm agroecosystem experiments in Canada." *Can. J. Soil Sci.* 90:543–550.
- Van Noordwijk, M., D. A. Suyamto, B. Lusiana, A. Ekadinata, and K. Hairiah. 2008. "Facilitating agroforestation of landscapes for sustainable benefits: tradeoffs between carbon stocks and local development benefits in Indonesia according to the FALLOW model." *Agriculture Ecosystems and Environment* 126:98–112.
- Williams, J. N., A. D. Hollander, A. Toby O'Geen, L. A. Thrupp, R. Hanifin, K. L. Steenwerth, and L. E. Jackson. In press . Assessment of carbon in woody plants and soil across a vineyard-woodland landscape. *Carbon Balance and Management*.

6.0 Investigating the Mitigation Potential of On-farm Renewable Energy in California: A Case Study of Dixon Ridge Farms

V. K. Mehta, V. Clark, and V. R. Haden

6.1 Introduction to On-farm Renewable Energy Project

The Global Warming Solutions Act of 2006 (AB 32) has been a catalyst for greenhouse gas (GHG) mitigation and has generated awareness of climate change adaptation in California's agricultural sector. While agriculture accounts for only 6 percent of the state's total GHG emissions, it has the potential to play a significant role in statewide mitigation efforts through the sequestration of carbon in soils and plant biomass and as a source of feedstock for renewable energy generation (ARB 2010; Jenkins et al. 2009). Agricultural residues are a major, and largely untapped, renewable energy source for California (Jenkins et al. 2009). Statewide estimates suggest that the potential feedstock from agricultural residues is over 8.8 million tons of dry biomass per year (Gildart et al. 2006). Various biomass-derived fuels (i.e., biofuels) can be used to partially displace fossil fuel consumption and facilitate GHG mitigation. Since agriculture tends to be particularly vulnerable to climate change, market volatility, and urban development, some have argued that on-farm energy generation using agricultural residues is a key way to link mitigation and adaptation to generate profitable co-benefits (McHenry 2009). Farmers can also become more independent from vacillations in supply and prices of fossil fuels. In short, mitigation strategies that integrate renewable energy sources into farm operations can themselves be viewed as an adaptation in response to climate change regulation.

California's net metering laws were established in 1995. They currently allow wind, solar, and some biogas installations to be connected to the energy grid through net metering accounts, provided they meet certain energy output and pollution-control requirements (Menz 2005). With the passage of AB 920,⁵ which became effective in 2011, residences, farms and businesses with renewable energy installations can also sell excess power back into the grid. In contrast, state policies have not previously allowed projects which generate electricity on-farm from crop residues to participate in these net metering programs. However, the Renewable Energy Equity Act (SB 489)⁶ which has been passed by the State Legislature, makes all forms of renewable energy eligible for California's net metering program. Now that SB 489 has removed this regulatory barrier, financing for projects which use crop residues for on-farm energy generation will be facilitated (Wiser and Pickle 1998; Faden 2000).

In this policy context, a case study of the mitigation potential of on-farm renewable energy generation is very timely. The main objective of this paper is therefore to evaluate the mitigation

⁵ Assembly Bill 920, Huffman, Chapter 376, Statutes of 2009.

⁶ Senate Bill 489, Wolk, Chapter 593, Statutes of 2011.

potential of current and future renewable energy generation on a single farm (Dixon Ridge Farms in Winters, California). This case study examines an organic walnut production and processing operation that uses rooftop solar photovoltaic (PV) panels and producer gas derived from the pyrolysis of walnut shells to generate electricity and partially offset the farm's consumption of grid electricity. A secondary goal of this study is to demonstrate a modeling tool, the Long-range Energy Alternatives Planning (LEAP)⁷ system, which can be used to plan energy activities at the farm scale. This study also uses the LEAP model to examine how the removal of regulatory barriers might facilitate on-farm electricity generation by the state's agricultural producers and processors.

6.2 Farm Description

The study was conducted at Dixon Ridge Farms, located close to the city of Winters, California. The farm was established in 1979 and is owned by Russ Lester and his family. Of the 1,250 acres owned by the farm, approximately 400 acres are in walnut orchards that are distributed across several ranches. The majority of the walnut production (~250 acres) is certified organic, with the remaining at various stages of transition, as it takes three years to transition to U.S. Department of Agriculture (USDA) certified organic status. Of the various farm operations, only spraying is contracted out to "custom operators." The operation is atypical in that it both produces and processes walnuts, i.e., small producers typically sell their walnuts to large processors (Hasey et al. 2006). Dixon Ridge processes walnuts from their own orchards and those from approximately 60 other organic growers. With a strong focus on sustainability, the farm has adopted practices such as no-till cover cropping, electricity-driven irrigation pumps (as opposed to diesel pumps), energy-efficiency improvements for chilling and lighting demand, on-farm electricity generation from both solar PV panels and a bioenergy plant, and waste-heat recycling used to dry walnuts. The current capacity of the solar PV unit is 17 kilowatts (kW), with plans for an additional 100 kW of solar PV based on available roof area. The current bioenergy plant is designed for 50 kW, but is run sub-optimally at 28 kW for most of the year because of load considerations and the legal inability of connecting the electricity output to the grid. Much of the energy and emissions mitigation potential comes from a walnut-shell bioenergy plant (tradename Biomax[®]) that is already in place.

The bioenergy plant at Dixon Ridge was developed and installed by the Community Power Corporation (CPC) with a grant funded by the California Energy Commission. A schematic of the bioenergy plant is shown in Figure 6.1. Walnut shells, which are a byproduct of the processing operations, are the feedstock for the bioenergy plant. After the walnut meat is removed, shells are placed in the feed hopper every four to five days with a forklift. From the feed hopper, shells are metered at 175 lb/hr into the gasifier of the Biomax plant, which heats the shells using a controlled air stream to gasify the carbon in the shells. The heat required for this is currently provided by grid electricity.

⁷ LEAP, developed by the Stockholm Environment Institute, www.sei-international.org; software distributed through the COMMEND website: www.energycommunity.org.

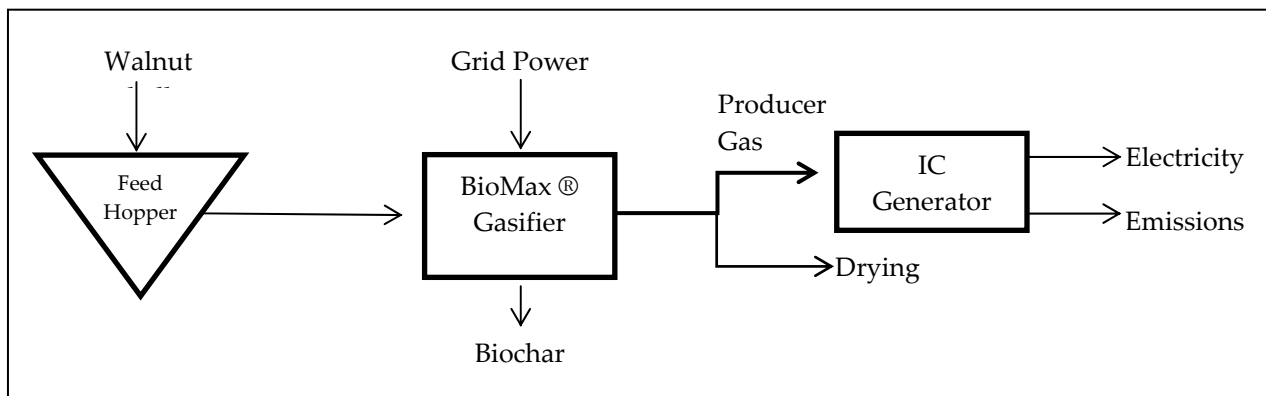

Figure 6.1. Schematic of the Biomax Unit, Which Consists of a Feed Hopper, a Pyrolytic Gasifier, and an Internal Combustion (IC) Generator. During walnut drying operations, producer gas can be diverted from the generator and used as a substitute for propane.

The gasification of the shells results in a stream of producer gas and a biochar by-product. The producer gas stream is then run through a heat exchanger to recover heat used in the drying of walnuts. The biochar is applied to soils in the orchard as a means of sequestering C and improving soil physical and chemical properties (Lehmann et al. 2006). The producer gas is used in one of two ways. For most of the year, it is used to fuel an internal combustion engine, which powers a generator to produce between 50–55 kW of electricity. During harvest (e.g., October) when drying is a major energy demand, the producer gas is burned in walnut dryers. This offsets a substantial amount of propane that would have typically been used.

6.3 Methods for LEAP Analysis

A scenario analysis was conducted for the farm by building a model using LEAP for energy planning and climate mitigation assessment, and to quantify energy demand and supply, and greenhouse gas emissions across any number of scenarios. The structure of the model is informed by modeling objectives as well as data availability.

6.3.1 Model Structure and Data Sources

Energy Demand

A comprehensive dataset of recent historical energy demand (2007 and 2010) on the farm was built from fuel and electricity bills provided by the farmer. Energy demand is distinguished into two main operational categories: growing and processing (Figure 6.2). These did not allow a comprehensive end-use demand analysis (e.g., amount of diesel used for tractors versus irrigation pumps), but did allow a distinction to be made between growing and processing. This distinction is important for the operations at Dixon Ridge, but also for other orchards which produce and deliver their dried walnuts to the processing facility at Dixon Ridge Farms.

On the growing side of the operation, energy is required for running equipment (e.g., tractors, harvesters trucks and tools), irrigation pumps, and for drying. Processing activities also include

chilling and shelling—billing records did not allow a separation of energy consumption between the two. Energy intensities were estimated on unit acreage basis for equipment and irrigation, and on unit-weight basis for drying, chilling, and shelling. Also under processing, we have included the transport of waste walnut shells to a centralized biomass power facility (Wheelabrator Technologies Inc., Anderson, California), which is located 140 miles away.

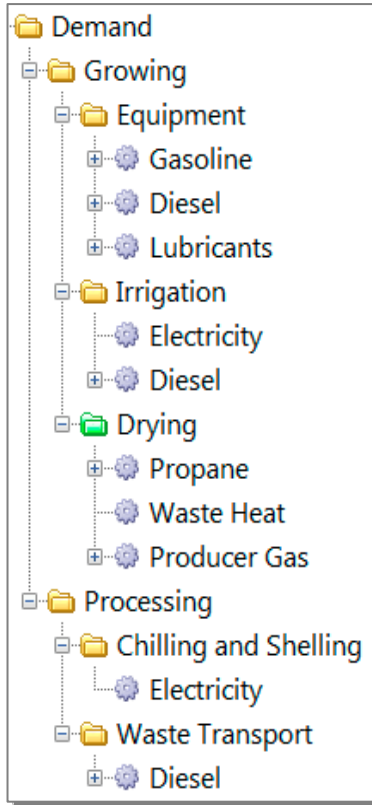

Figure 6.2. Configuration of Demand Branches in LEAP

Energy Supply

On the energy supply side, LEAP uses a transformation module that includes all processes where primary fuels are transformed into secondary fuels. In this study, the transformation analysis includes electricity generation (both on- and off-site), and production of by-products from the Biomax power plant. Electricity used on the farm is produced from three distinct sources: the Pacific Gas & Electric grid, on-site rooftop solar panels, and on-site bioenergy generation from walnut shells. Electricity demands are always first met by solar and the bioenergy plant, and the remaining demands are met by grid electricity. Based on historical performance, on-site solar and biomass generators were assumed to operate at 10 percent and 70 percent availability respectively.⁸ The fuel mix of grid electricity was assumed to be the same

⁸ Availability is an electric generator performance characteristic, and is defined as the maximum percentage of time a generator is available to generate electricity. Intermittent renewables, such as solar, have much lower availabilities because electricity generation depends on consistent sunlight.

as the Energy Information Administration (EIA) fuel mix for California in 2009 as seen in Table 6.1. When the bioenergy plant is operating, waste heat and producer gas are created as by-products. Each of these can then be used to displace propane in drying operations. The production of these alternative fuels is modeled under the transformation analysis in LEAP. All technical characteristics of the Biomax unit were obtained from CPC reports (The Avogadro Group, LLC 2009). Biomass feedstock (walnut shells) was estimated to be 400 short tons per biomass power plant unit per year, based on farmer input on past usage. Additional variables such as yield, shell weight, in-shell sales, and processing of imported walnuts are included as state variables in the model such that alternative scenarios (e.g., changes in yield, acreage) could be modeled in the future.

Table 6.1. Assumed Fuel Mix from Grid Electricity Supplied to Dixon Ridge Farm

Fuel source	Fuel (%)
Natural gas	56.6
Nuclear	15.5
Hydroelectric	13.6
Renewable (solar, wind, and biomass)	12.5
Coal	1.0
Petroleum	0.8

Source: http://www.eia.gov/cneaf/electricity/st_profiles/california.html

Emissions Factors

Emissions associated with growing and processing were estimated using the IPCC’s standard Tier 2 emission factors for conventional fuels and gas produced from biomass (IPCC 2006) (Table 2). Emissions from carbon dioxide (CO₂), methane (CH₄), and nitrous oxide (N₂O) were standardized as carbon dioxide equivalents (CO₂e) according to their global warming potential (IPCC 2006). Emissions of CO₂ (but not CH₄ and N₂O) from biomass-derived producer gas are considered to be biogenic, thus offsetting any non-biogenic emissions from the combustion of fossil fuels. This would include propane used for on-site drying, as well as the portfolio of fossil fuels used in producing grid electricity. Electricity from solar PV also displaces non-biogenic emissions from the grid.

Emissions Mitigation Scenarios

A scenario is a storyline of how a particular energy system might evolve over a future time period. Scenarios are not a prediction of what will happen with particular certainty, but rather, a representation of one reasonable future for this farm over the time period of 2011 to 2020 under particular assumptions. Over the course of four consultations in June 2011 with the farmer, the following four scenarios were developed and represented in the model.

- Business as Usual (BAU) – *What would the Dixon Ridge Farm energy system look like without any mitigation measures?* This scenario represents Dixon Ridge Farm without mitigation options. This includes no change from energy demand values in 2010, and all demand is

met with conventional fuel sources (e.g., diesel, grid electricity, propane). On-site generation from PV and biomass is not included in this scenario. All walnut shells are assumed to be transported to a centralized biomass power facility.

- Renewable Generation (REN) – *What is the mitigation impact of Dixon Ridge Farm’s current renewable generation measures?* This scenario describes the current state of Dixon Ridge Farm in 2011, including present levels of rooftop solar PV generation (17 kW) and biomass electricity (one Biomax unit operating at 28 kW) and heat production. Producer gas and waste heat from the on-site bioenergy plant is assumed to partially displace propane use in drying operations. The consumption of walnuts shells by the on-site bioenergy plant currently reduces the total amount transported to the centralized biomass power facility by 400 short tons (47 percent of 850 short tons total shells). No change in these assumptions is assumed after 2011.
- Mitigation 1 (M1 = REN + SOL + BIO) – *What is the energy mix and mitigation potential of anticipated renewable expansion by 2015?* This scenario combines all of the measures that are currently in place, and simulates anticipated expansion of renewables as follows:
 - Solar PV Expansion (SOL) – An expansion of rooftop solar PV panels from 17 kW to 100 kW. This new capacity is expected to come online in 2012.
 - Bioenergy plant expansion (BIO) – This assumes that a second bioenergy plant (e.g., two Biomax units) operating at a capacity of 28 kW is added in 2015. Current walnut production, deliveries, and processing levels are able to support a second bioenergy plant. This additional capacity increases heat and producer gas production, allowing propane to be fully displaced in drying operations by 2015. The additional bioenergy plant also reduces the amount of walnut shells that must be transported to the centralized biomass plant by 94 percent relative to BAU.
- Mitigation 2 (M2 = M1 + SB 489 + 3 BIO) – *What is the possible impact of SB 489 induced measures on renewable energy production and emission mitigation?* This scenario includes all mitigation measures which are already planned (M1) and those made possible with the future passing of SB 489 as follows:
 - SB 489 – This scenario explores the impact of California’s Renewable Energy Equity Act becoming law by 2013, thus allowing net metering of on-site biomass energy generation. At Dixon Ridge Farm, this would mean being able to increase the running capacity of each Biomax unit from 28 kW to a full 50 kW capacity.
 - 3 Biomass Units (3 BIO) – This scenario explores the possibility of two additional biomass power plants coming online in 2015. Walnut processing operations were assumed to steadily increase from 2010 to 2015 to meet the walnut-shell feedstock requirements of a third unit with no additional transport necessary. A third biomass unit is considered financially feasible only with operational improvements gained through the passage of SB 489.

Before proceeding, we should highlight a few caveats regarding the scope of our analysis. The scenarios in this analysis do not cover the efficiency improvements that have already taken place on Dixon Ridge Farm. Nor do they cover several non-energy sector emissions related to other production activities that occur on the farm. For example, there are non-energy-related emissions related to production activities such as pruning (and the fate of clippings), mowing, tillage, fertilization, and pesticide application, which are site specific and often highly uncertain. Our study also did not examine the differences in the emissions related to activities that are different for organic and conventional production. For example, conventional fertilizers likely have a larger non-biogenic CO₂ footprint from the fertilizer production component compared to organic fertilizers. Also organic walnut production requires chilling, as opposed to methyl bromide fumigation. This implies a trade-off between greater energy and energy-related emissions, versus the use of methyl bromide, which in itself is a gas with high global warming potential. Since our analysis was restricted to comparing alternative scenarios on a single farm that grows and processes organic walnuts, an assessment of the differences between organic and conventional operations was beyond the scope of our analysis.

Table 6.2. LEAP Branches and IPCC Tier 2 Emission Factors (EF) Expressed in kg of Gas Per Terajoules (TJ) of Energy for the Fuel Types Used at Dixon Ridge Farm

Fuel type ^a	IPCC 2006 Cat. / Subcat.	LEAP Branches	EF CO ₂	EF CH ₄	EF N ₂ O
			----- kg gas TJ ⁻¹ -----		
Gas from biomass	Stationary sources / Manufacturing (includes food processing)	Growing\Drying\Producer Gas	54,600 ^b	1.0	0.1
Liquefied petroleum gases	Stationary sources: Manufacturing (includes food processing)	Growing\Drying\Propane	63,100	1.0	0.1
Diesel	Mobile sources: Offroad agricultural machinery	Growing\Equipment\Diesel	74,100	4.15	28.6
Diesel	Mobile source: road transport	Processing\Waste Transport\Diesel	74,100	3.9	1.3
Diesel	Stationary source: agriculture	Growing\Irrigation\Diesel	74,100	10	0.6
Gasoline	Mobile source: offroad agricultural machinery: 2-stroke engine	Growing\Equipment\Gasoline	69,300	140	0.4
Natural Gas	Stationary sources: Energy Industries (for Grid categories)	Transformation\Electricity\Processes\Grid\Natural Gas	56,100	1.0	0.1
Diesel	Stationary sources: Energy Industries (for Grid categories)	Transformation\Electricity\Processes\Grid\Petroleum	74,100	3.0	0.6
Other Bituminous Coal	Stationary sources: Energy Industries (for Grid categories)	Transformation\Electricity\Processes\Grid\Coal	94,600	1.0	1.5
Lubricants	Stationary sources: Agriculture/forestry/fishing farms	Growing\Equipment\Lubricants	73,300	10.0	0.6

^aCO₂ emissions from biomass (e.g., walnut shell producer gas) are considered biogenic emissions.

6.4 Results of the LEAP Analysis

6.4.1 Energy Demand and Benefits of Renewable Generation

Propane (for drying), diesel (for equipment, irrigation, and walnut shell waste transport), and electricity (for irrigation, drying, chilling, and shelling) are the dominant fuels being modeled in the BAU scenario, which assumes no on-farm generation from renewable sources (Figure 6.3). The total annual energy demand at Dixon Ridge Farm under the BAU scenario is approximately 14,000 gigajoules (GJ). Energy consumption is dominated by petroleum products used in the growing operations, while electricity accounts for 25 percent of the total energy consumption (Figure 6.3). The total GHG emissions under the BAU scenario are estimated at 919 tons (t) CO_{2e} (Figure 6.4). A breakdown of emissions by fuel type indicates that propane combustion is responsible for 45 percent of emissions, followed by diesel (32 percent), grid electricity (21 percent), and other petroleum products.

The REN scenario represents the current status of the farm's energy portfolio, including on-site energy generation from solar PV (17 kW) and one Biomax unit (28 kW) running on producer gas. Figure 6.3 compares the fuel sources under the BAU and REN scenarios. The Biomax unit displaces over half of the propane requirements for drying, equal to over 3,000 GJ (Figure 6.3). Electricity demands continue to be met by predominately by grid electricity, but the PV and Biomax units are able to displace close to 20 percent of total electricity demand (Figure 6.5). Accounting for the displacement of propane and grid electricity by producer gas, as well as a reduction in waste transportation emissions, renewable energy sources reduced emissions by 245 t CO_{2e} yr⁻¹ (Figure 6.4). Approximately 81 percent of the emission reductions in the REN scenario come from the replacement of propane with producer gas, which is renewably generated from walnut shells. Under this scenario, the solar PV and Biomax units generate 187 kWh of electricity annually and together reduce emissions by 37.3 t CO_{2e} yr⁻¹ per year relative to the BAU scenario.

6.4.2 Expansion of Renewable Generation (M1 Scenario)

As described earlier, the M1 scenario assumes expansion of solar PV generation to 100 kW and increased bioenergy production by installing one additional Biomax unit with the generator operating at 28kW in 2015. The energy demand remains the same as in previous scenarios, as no expansion in production or processing is assumed. Under the M1 scenario, producer gas from the two Biomax units can replace all of the propane required for walnut drying. The remaining producer gas is also used to generate 700 kWh of electricity on site. This is equivalent to 64 percent of the total electricity demand (Figure 6.5). Including the solar PV, 73 percent of electricity demand can be met by on-farm renewable energy sources under the M1 scenario. Overall, the M1 scenario reduced emissions by approximately 62 percent relative to the BAU scenario (Figure 6.4).

6.4.3 Enhanced Mitigation Facilitated by SB 489 (M2 Scenario)

The M2 scenario includes all mitigation measures planned and possible with the passing of SB 489, which will enable the Biomax units to run at design load (50 kW). The new state policy

also facilitates the addition of two more Biomax units, for a total operating capacity of 150 kW (R. Lester, pers. comm). Since walnut shell supply would have to increase to support increased bioenergy generation, the energy demand for both growing and processing increases with increased production of walnuts, to a total 17,265 GJ yr⁻¹, by 2015 (Figure 6.5, Figure 6.6). Under the M2 scenario, renewable energy sources meet 81 percent of electricity demand, with producer gas supplying 74 percent (Figure 6.6). As with the M1 scenario, all propane is able to be replaced with producer gas. Thus, by 2015, producer gas accounts for slightly more than 50 percent of the total fuel share. Overall, the M2 scenario reduced emissions by 62 percent relative to BAU levels in 2015 (Figure 6.4). These emissions reductions are mostly obtained by using producer gas for drying operations instead of propane (72 percent). Decreased use of grid electricity (25 percent) and avoided walnut shell waste transport (3 percent) make up the remainder of the emission reductions.

6.4 Discussion of On-farm Renewable Energy Projects

High energy prices and volatile energy markets have been a longstanding concern among California farmers. Studies also suggest that farmers in California are more inclined to adopt GHG mitigation practices that also offer direct private benefits; prime examples being measures to reduce their energy consumption and/or install technologies to generate renewable energy on-farm (see Section 4 of this paper). As such, the progression of California's net metering laws has helped to spur investment in on-farm renewable energy projects; particularly solar, wind, and biogas. The recent passing of SB 489 will allow California farmers who generate electricity from agricultural residues to participate in these net-metering programs, thus providing a strong incentive for them to consider the benefits and tradeoffs of using agricultural residues to supplement their energy needs, rather than for another purpose, such as animal feed.

The results of this study suggest that solar PV and producer gas derived from agricultural residues (in this case, walnut shells) have significant potential to reduce reliance on purchased electricity and propane used in growing and processing operations (i.e., private benefits), while also reducing their GHG emissions (i.e., public benefits). At Dixon Ridge Farms, upwards of 70 percent of the total energy demand and more than 80 percent of electricity demand could be met through the addition of 100 kW of solar PV and an expansion of bioenergy generation to three Biomax units running at full capacity (50 kW each). These measures would also allow for nearly 40 percent growth in the farm's processing operations, while reducing total emissions by 62 percent relative to the scenario that assumed no renewable generation (i.e., BAU) and 50 percent relative to the farm's current suite of renewable generation measures (i.e., REN). On-farm emissions reductions are achieved primarily through the complete displacement of purchased propane for drying, reduced reliance on grid electricity, and eliminating the need to transport walnut shells to a distant waste facility.

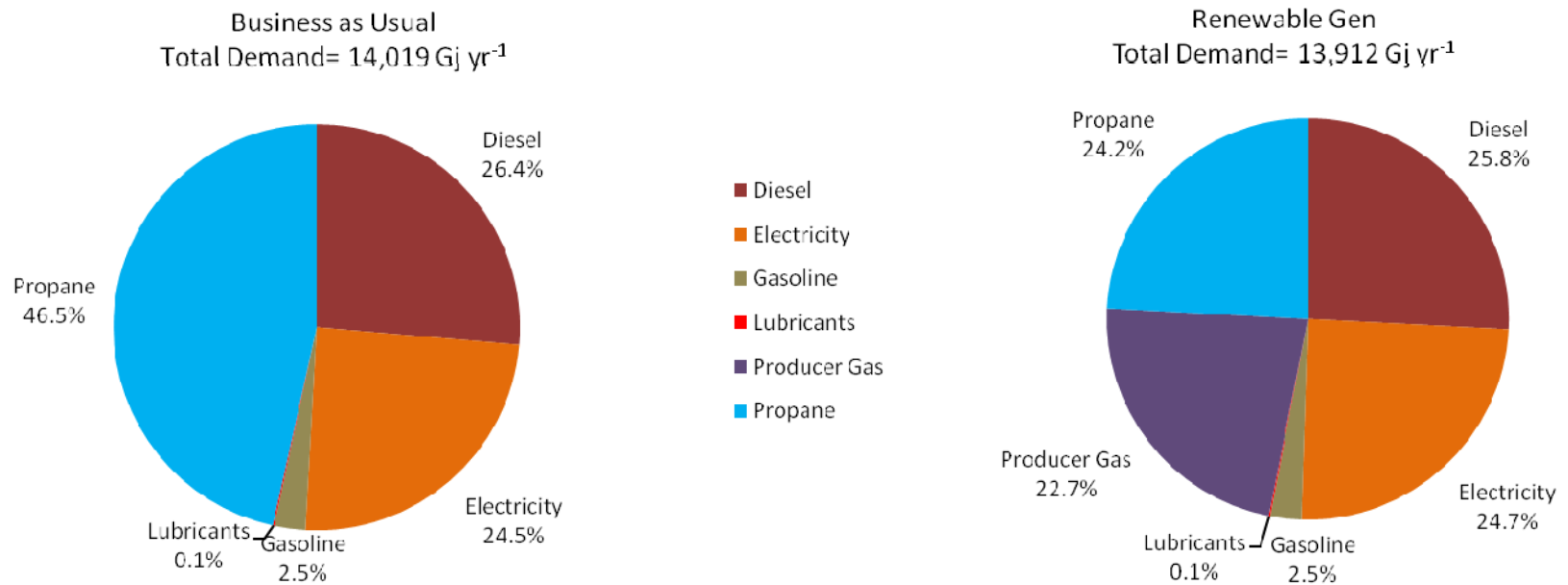

Figure 6.3. Percent Contribution of Energy Sources to Total Energy Demand in 2011 for Growing and Processing Walnuts at Dixon Ridge Farms under (A) BAU Scenario (total BAU demand = 14,019 GJ) and (B) REN Scenario (total REN demand = 13,913 GJ). Propane demand is displaced by producer gas (3,360 GJ) in the REN scenario. The small difference in energy demand between the scenarios is associated with avoided diesel for transporting walnut shell waste off-site.

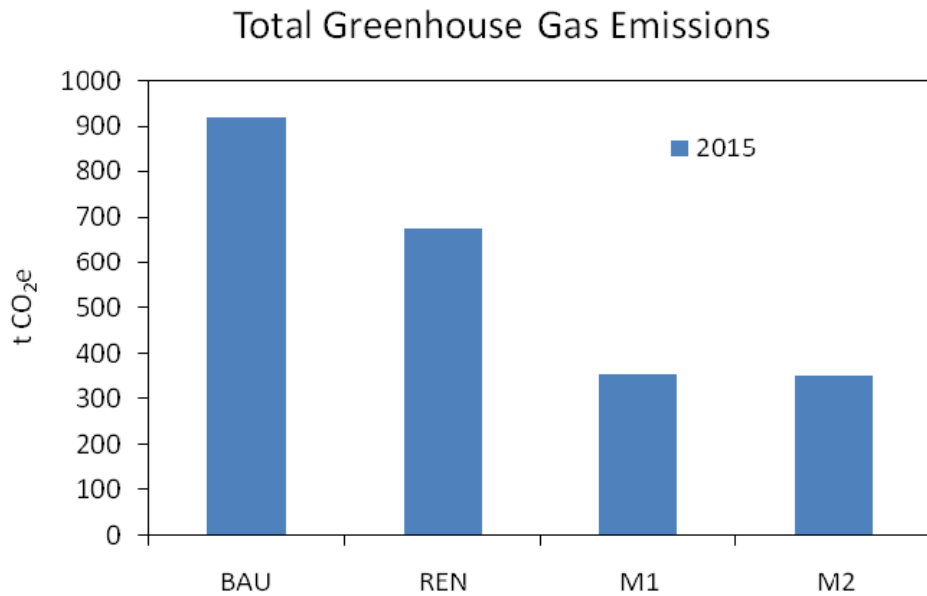

Figure 6.4. Estimated GHG Emissions for the Business-as-Usual (BAU), Renewable Energy Generation (REN), Mitigation 1 (M1), and Mitigation 2 (M2) Scenarios in 2015

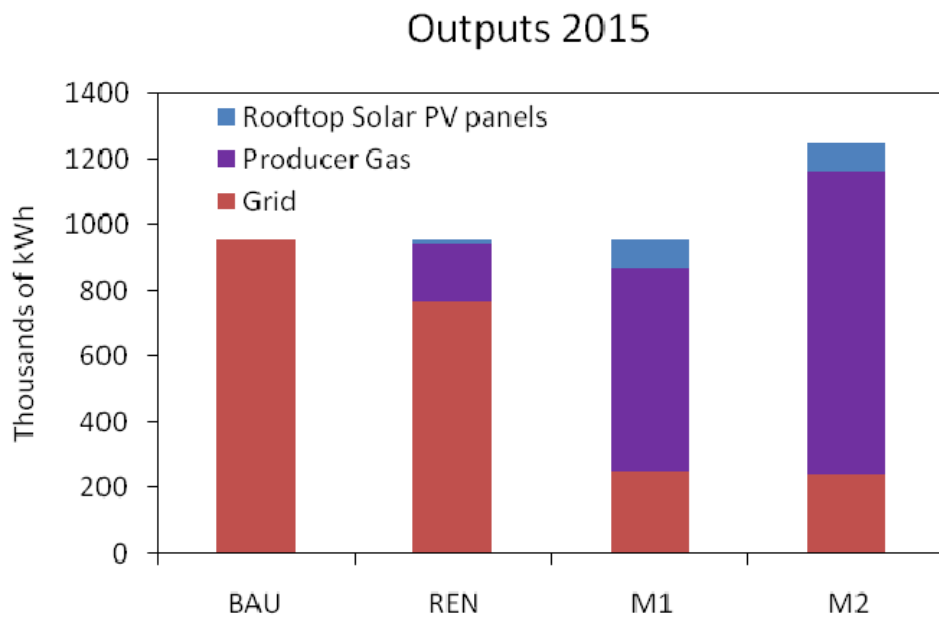

Figure 6.5. Amount and Source of Electricity (thousands of kWh) for the Business-as-Usual (BAU), Renewable Energy Generation (REN), Mitigation 1 (M1), and Mitigation 2 (M2) Scenarios in 2015

Transformation Outputs

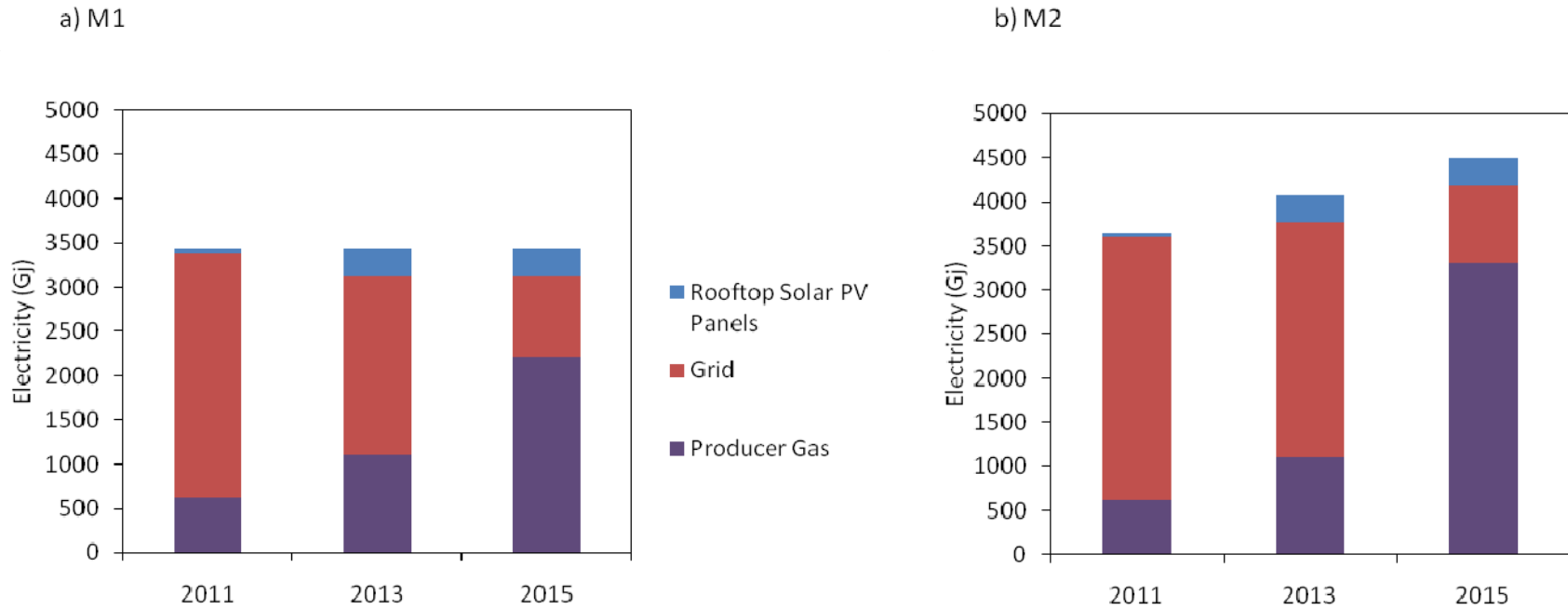

Figure 6.6. Electricity Generation Requirements by Source for the (a) Mitigation 1 Scenario (M1) and (b) Mitigation 2 Scenario (M2). Requirements for electricity grow in the M2 scenario as walnut processing increases, but a larger portion of the farm's requirements can be met by the expanded electricity generation capacity due to three Biomax units.

It is important to note the scope of the analysis presented here. We have focused on current and planned on-site renewable energy measures and associated emissions reductions. The mitigation option with the largest potential to reduce GHG emissions is expanding the number of Biomax units to generate more producer gas to replace propane in drying operations and generate electricity on-site. Our emissions analysis includes the waste transportation emissions that occur due to the expansion of the on-site biomass power plant. Although we have included waste transport emissions, those have proved to be quite small. While we include in our analysis the emissions related to grid-electricity consumption (assuming the published fuel mix for California utilities), we do not attempt to address transmission losses or upstream (e.g., mining of primary resources) processes related to grid electricity generation. These were beyond the scope of the study.

Despite the private and public benefits demonstrated above, farmers' eventual decisions to invest in on-farm renewable energy must be driven by a careful analysis of the financial costs and benefits. In this context, it should be noted that the LEAP decision support software used in this project has the capacity to include financial routines that can facilitate economic analysis. Future LEAP studies could combine on-farm energy data with crop-specific cost and return studies, and could be made available through the University of California Cooperative Extension, helping farmers who grow and process a wide range of agricultural products to consider the potential for integrating renewable energy projects into their operations.

6.6 References

- The Avogadro Group, LLC. 2009. Biomax Emissions Testing Report, Filed for compliance with California air quality regulations.
- ARB. 2010. California Greenhouse Gas Inventory for 2000–2008. California Environmental Protection Agency, Air Resources Board, Sacramento, California.
- DWR. 1997. *Yolo County Land and Water Use Survey*, Sacramento, California: California Department of Water Resources.
- Faden, V. J. 2000. "Net Metering of Renewable Energy: How Traditional Electricity Suppliers Fight to Keep You in the Dark." *Widener Journal of Public Law* 10 (1): 109–134.
- Gildart, M., R. Williams, and L. Yan. 2006. *An assessment of biomass resources in California*. Sacramento, California: California Biomass Collaborative/California Energy Commission.
- Hasey, J., K. Klonsky, and R. L. De Moura. 2006. *Sample costs to produce English Walnuts on 100, 20, 5 acre orchards in the Sacramento Valley*. University of California Cooperative Extension.
- IPCC. 2006. *2006 IPCC Guidelines for National Greenhouse Gas Inventories*. Japan: IGES.
- Jenkins, B., et al. 2009. "Sustainable use of California biomass resources can help meet state and national bioenergy targets." *California Agriculture* 63(4): 168–177.

- Lehmann, J., J. Gaunt, and M. Rondon. 2006. "Bio-char sequestration in terrestrial ecosystems - A review." *Mitigation and Adaptation Strategies for Global Change*. 11: 403–427.
- McHenry, M. P. 2009. "Agricultural bio-char production, renewable energy generation and farm carbon sequestration in Western Australia: Certainty, uncertainty and risk." *Agriculture, Ecosystems and Environment* 129: 1–7.
- Menz, F. C. 2005. "Green electricity policies in the United States: Case study." *Energy Policy* 33: 2398–2410.
- Wiser R., and S. Pickle. 1998. *Financing Investments in Renewable Energy: The Role of Policy Design and Restructuring*, Lawrence Berkeley National Laboratory.

Glossary

AB 32	Assembly Bill 32, the Global Warming Solutions Act of 2006
ABAG	Association of Bay Area Governments
AG	aboveground
ARB	California Air Resources Board
AVI	Agricultural Vulnerability Index
BAU	business-as-usual
BCCA	Bias Corrected Constructed Analog
BIO	bioenergy plant expansion
C	carbon
CAGO	California Attorney General's Office
CAML	California Augmented Multipurpose Landcover
CAR	Climate Action Reserve
CDFA	California Department of Food and Agriculture
CEDD	California Employment Development Department
CH ₄	methane
CM2.1	GFDL climate model 2.1
CPC	Community Power Corporation
CV	climate vulnerability
D	Simpson dominance index
DBH	diameter at breast height
DNDC	DeNitrification-DeComposition
eCO ₂	elevated carbon dioxide
EF	emission factors
EIA	Energy Information Administration
EWG	Environmental Working Group
FEMA	Federal Emergency Management Agency

GCM	general circulation model
GFDL	Geophysical Fluid Dynamics Laboratory
GHG	greenhouse gas
GIS	geographic information system
GJ	gigajoules
H	Herfindahl-Hirschmen index
IC	internal combustion
ICE	UC Davis Information Center for the Environment
IPCC	Intergovernmental Panel on Climate Change
kt	kilotons
kW	kilowatt
LEAP	Long-range Energy Alternatives Planning
M1	Mitigation 1
M2	Mitigation 2
MPO	Metropolitan Planning Organization
N	nitrogen
N ₂ O	nitrous oxide
NASS	National Agriculture Statistics Service
NCDC	National Climatic Data Center
NOAA	National Oceanic and Atmospheric Administration
PC	principal components
PCA	principal component analysis
PCM	parallel climate model
PET	potential evapotranspiration
PIER	Public Interest Energy Research Program
PV	photovoltaic
RD&D	research, development, and demonstration
REDD	Reduce Emissions from Deforestation and Forest Degradation

REN	Renewable Energy Generation
SACOG	Sacramento Area Council of Governments
SB	Senate Bill
SCS	sustainable communities strategies
SD	standard deviation
SG	smart growth
SMAQMD	Sacramento Metropolitan Air Quality Management District
SOAR	Save Open Space and Agricultural Resources
SOC	soil organic carbon
SOL	Solar PV Expansion
SSURGO	USDA Soil Survey Geographic Database
t	tons
UC	University of California
UGBs	Urban Growth Boundaries
UPlan	An urban growth model
USDA	U.S. Department of Agriculture
U.S. EPA	U.S. Environmental Protection Agency
WEAP	Water Evaluation and Planning
WRA	Water Resources Association